

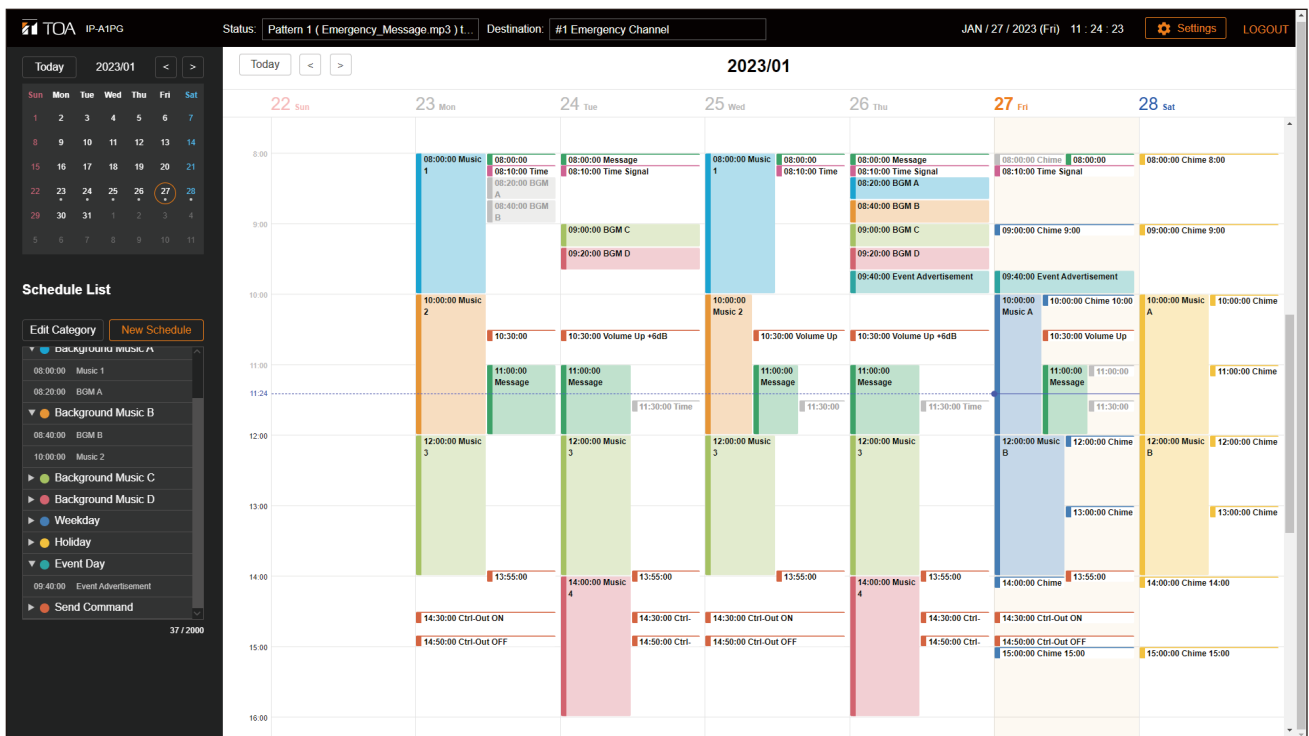

TOA

TRANSMITTING DEVICE SETUP MANUAL

IP AUDIO SERIES



This manual provides the following explanations:

- Setup and operation of the IP-A1 Device using a web browser.
- Setting up the Device's detection and network settings using the IP Setting Tool.

For instructions on how to install and perform initial settings on the device, please refer to the Instruction Manual supplied with the product.

- Devices covered by this manual:
IP-A1PG IP Paging Gateway
IP-A1RM IP Remote Microphone

- The explanations in this manual only apply to firmware versions 3.3.0 or later.

Thank you for purchasing TOA's IP Audio Series.

Please carefully follow the instructions in this manual to ensure long, trouble-free use of your equipment.

TABLE OF CONTENTS

| | |
|--|----|
| 1. INTRODUCTION | 4 |
| 1.1. About This Manual | 4 |
| 1.2. System Requirements | 4 |
| 1.3. Security Measures | 4 |
| 2. ABOUT THE BROADCAST SYSTEM AND ITS SETUP | 5 |
| 2.1. Broadcast System Models | 5 |
| 2.2. Settings Flow by Model | 10 |
| 3. CONNECTION WITH BROWSER | 27 |
| 3.1. Connection Presets | 27 |
| 3.2. Making Connection | 27 |
| 4. CURRENT DATE AND TIME SETTINGS | 28 |
| 4.1. Automatic Date and Time Synchronization with the NTP Server | 28 |
| 4.2. Synchronization with a Connected PC's Clock (Date and Time) | 28 |
| 4.3. Manual Date and Time Settings | 29 |
| 5. OPERATIONS COMMON TO EACH SCREEN | 30 |
| 5.1. Screen Layout | 30 |
| 5.2. Saving Settings or Changed Contents | 31 |
| 5.3. Restarting the Device | 32 |
| 5.4. Logging Out | 32 |
| 6. SETTINGS | 33 |
| 6.1. About the Setting Menu Composition of Each Model | 33 |
| 7. STATUS SCREEN DISPLAY | 35 |
| 7.1. Status Screen and Status Indicators | 36 |
| 8. KEY SETTINGS SCREEN | 37 |
| 9. NETWORK SETTINGS SCREEN | 40 |
| 10. SIP SETTINGS SCREEN | 41 |
| 11. VMS BROADCASTING SETTINGS SCREEN | 43 |
| 12. DESTINATION SETTING SCREEN | 44 |
| 13. CONVERSION SETTINGS SCREEN | 45 |
| 13.1. SIP Broadcasting Conversion Setting | 45 |
| 13.2. VMS Broadcast Conversion Settings | 47 |
| 13.3. When Converting from SIP to Multicast Broadcasting | 48 |
| 14. AUDIO SETTINGS SCREEN | 52 |
| 14.1. Conceptual Diagram of the Sound Volume Settings Function | 54 |
| 15. MEDIA SETTING SCREEN | 56 |
| 15.1. Uploading Sound Source Files | 58 |
| 15.2. Downloading Sound Source Files | 58 |
| 15.3. Deleting Sound Source Files | 59 |
| 16. CHIME SETTINGS SCREEN | 60 |
| 17. PATTERN REGISTRATION SCREEN | 61 |
| 17.1. Performing Tests of Pattern Broadcast | 64 |

| | |
|---|-----|
| 18. EVENT SETTINGS SCREEN | 65 |
| 19. PRIORITY SETTINGS SCREEN | 71 |
| 20. COMMAND LIST SCREEN | 74 |
| 20.1. Command List Makeup | 74 |
| 21. USER SETTINGS SCREEN | 76 |
| 22. MAINTENANCE SCREEN | 77 |
| 22.1. Downloading Setting File | 78 |
| 22.2. Uploading Setting File | 79 |
| 22.3. Initialization of Settings | 80 |
| 22.4. Factory Default Settings | 81 |
| 22.5. Firmware Update | 82 |
| 22.6. Downloading the Log File | 83 |
| 23. SYSTEM SETTINGS SCREEN | 88 |
| 24. USABLE CHARACTERS | 90 |
| 24.1. Characters That Can Be Used for Names, Authentication ID and Passwords | 90 |
| 24.2. Characters That Can Be Used for Filenames | 92 |
| 25. THE SCHEDULER | 93 |
| 25.1. About the Scheduler Function | 93 |
| 25.2. Scheduler Screen | 96 |
| 25.3. Creating a New Schedule | 98 |
| 25.4. Check/Edit/Delete Schedules | 106 |
| 25.5. Task Display and Operation | 108 |
| 25.6. Confirm/Edit/Delete Tasks | 110 |
| 25.7. Editing the Category | 113 |
| 25.8. Schedule Setting Error Messages | 116 |
| 25.9. Schedule Data Reset | 117 |
| 25.10. Uploading the Configuration File (minus Schedule data) | 117 |
| 26. IP SETTING TOOL | 118 |
| 26.1. Before Using: | 118 |
| 26.2. Starting the IP Setting Tool | 118 |
| 26.3. Setting Method | 119 |
| 26.4. User Authentication | 121 |
| 26.5. Network Settings | 121 |
| 26.6. Uploading Settings Files | 124 |
| 26.7. Downloading Settings Files | 125 |
| 26.8. Firmware Update | 126 |
| 26.9. Restarting the Device | 127 |
| 27. SIP STATUS DISPLAY SCREEN | 128 |
| 28. TROUBLESHOOTING | 131 |
| 29. WHAT TO DO WHEN IN TROUBLE | 135 |

1. INTRODUCTION

1.1. About This Manual

This manual covers the following models:

IP-A1PG IP Paging Gateway
IP-A1RM IP Remote Microphone

Furthermore, the explanations in this manual only apply to firmware versions 3.3.0 or later.

The display screens used in this manual are mainly related to the IP-A1PG IP Paging Gateway. The actual screens may differ slightly depending on the model.

Additionally, some functions and settings may differ depending on the model. In this manual, if a description applies only to a specific model, the following warning will be displayed:

- PG** Applies only to IP-A1PG.
- RM** Applies only to IP-A1RM.

1.2. System Requirements

Recommended PC operational environments are as follows:

| | |
|---------|--|
| Display | Resolution: 1920 x 1080 or greater |
| OS | Windows 10 Pro (64bit) Windows 10 Home (64bit) Windows 11 Pro Windows 11 Home |
| Browser | Microsoft Edge Google Chrome |

Notes

- Microsoft Edge is the registered trademark of Microsoft Corporation in the United States and other countries.
- Google Chrome is the trademark of Google LLC in the United States and other countries.

1.3. Security Measures

- Ensure that sufficient security measures are taken on the customer's own responsibility.
- TOA Corporation takes no responsibility for damage or loss caused by security-related problems, such as illegal access.
- To help prevent illegal access to the device, be sure to change the user ID and password from those used for initial setup. For setting methods and other details, please refer to the User Settings Screen on [p. 76](#).
- Take utmost care in the management of the device's communications password.

2. ABOUT THE BROADCAST SYSTEM AND ITS SETUP

Broadcast systems can be assembled based on various combinations of "Broadcast System Models." This manual provides explanations of the setup method used for each broadcast model.

2.1. Broadcast System Models

Broadcast system models are classified by (1) the sound source to be broadcast and (2) the form of the broadcast made to each destination. Performing settings can be greatly facilitated by first knowing which model is being used.

2.1.1. Scheduled broadcasts of sound source files

Example 1-1. Broadcasting from the Internal Sound Source of individual receiving devices

When broadcasting to several individual IP Audio receiving devices, often under varying broadcast conditions, broadcasting from each device's internal sound source can be accomplished by creating patterns using the sound source files pre-loaded into every IP speaker.

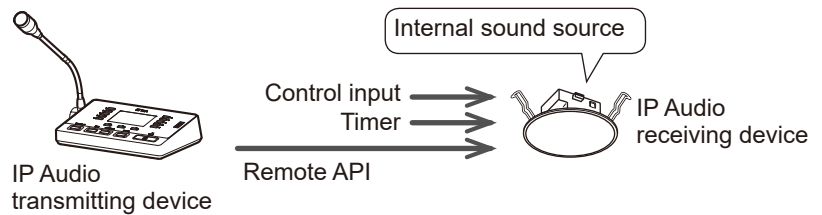

Example 1-2. Individual SIP Broadcasting from the Internal Sound Source

When broadcasting the IP Remote Microphone's internal sound source file to each IP audio receiving device, first create a broadcast pattern and then establish a SIP connection to the intended IP audio receiving device.

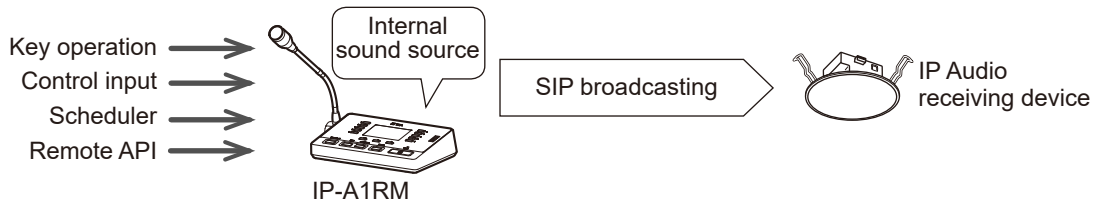

Example 1-3. Group Broadcasting from an Internal Sound Source

When broadcasting simultaneously to multiple IP audio receiving devices using the same sound source file, create a pattern using the sound source file(s) loaded in the IP Audio transmitting device and transmit them by multicast broadcasting. This function is also useful for collectively managing scheduled broadcasts using the Scheduler.

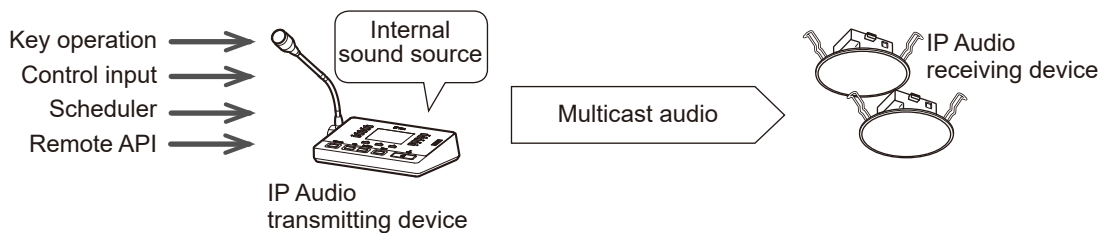

2.1.2. Broadcasting from analog sound sources, such as audio players

Example 2-1. Local Broadcasting from the IP Audio Interface

When using a single IP audio interface to broadcast an analog audio source, perform Local Broadcasting from a microphone or audio player that's been connected directly to the IP audio interface. If a microphone is being used, real time PA (public address) broadcasts can be made by setting the Mode to No Delay.

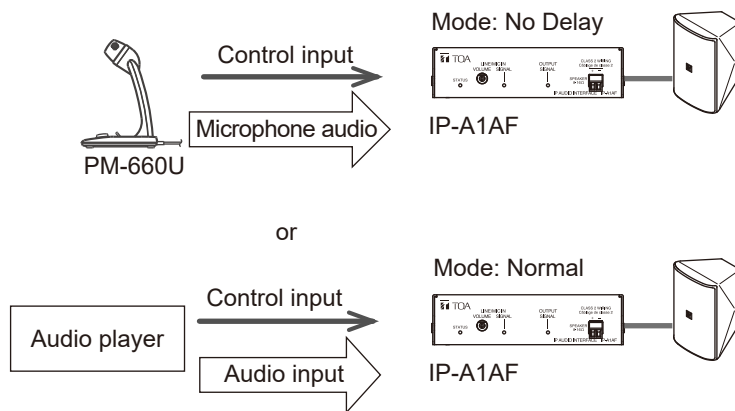

Example 2-2. Individual SIP Broadcasting from Analog Sound Sources

When broadcasting to each IP audio receiving device from an analog audio source connected to the IP Remote Microphone, first connect the audio player to the IP Remote Microphone, then perform broadcasting using a SIP connection.

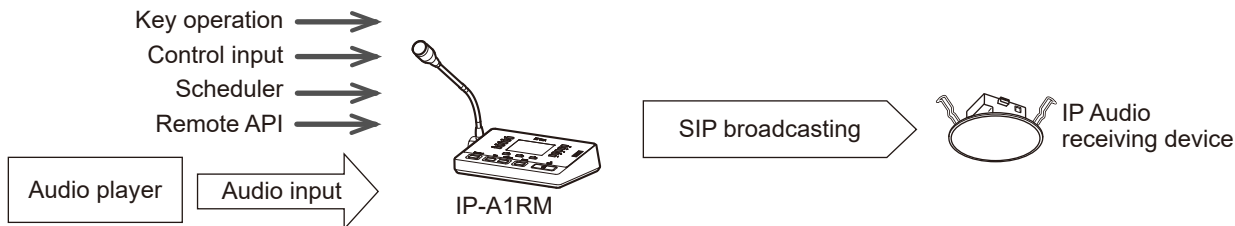

Example 2-3. Group Broadcasting from Analog Sound Sources

When simultaneously broadcasting from an analog sound source to multiple IP audio receiving devices, enable multicast broadcasting from the audio player connected to the IP Audio transmitting device.

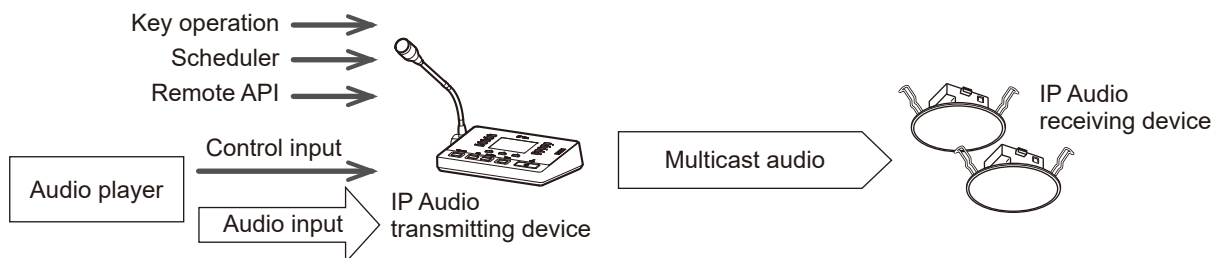

2.1.3. Real time PA (Public Address) broadcasting from a microphone

Example 3-1. Individual SIP Broadcasting to IP Audio receiving devices

When transmitting individual real time PA broadcasts from a device such as IP Remote Microphone or a SIP phone to each of the system's IP Audio receiving devices, enable SIP broadcasting by establishing a direct SIP connection to each intended IP Audio receiving device.

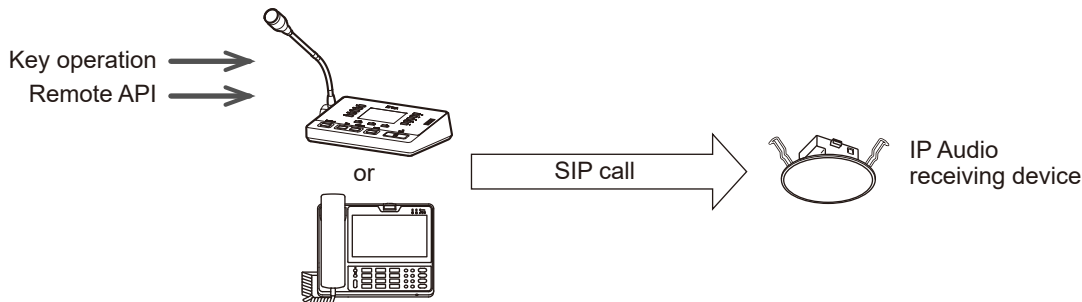

Example 3-2. PA (Public Address) Group Broadcasting from a SIP device

When simultaneously transmitting PA broadcasts from SIP devices such as the IP Remote Microphone or a SIP phone to multiple IP Audio receiving devices, perform multicast broadcasting using the IP Paging Gateway. When broadcasting from the SIP phone, the multicast channel to be converted can be changed by designating the DTMF number to allow the broadcast destination groups to be switched. Multicast broadcasts to the IP Paging Gateway's preset broadcast destination can also be done without using the DTMF signal transmission method.

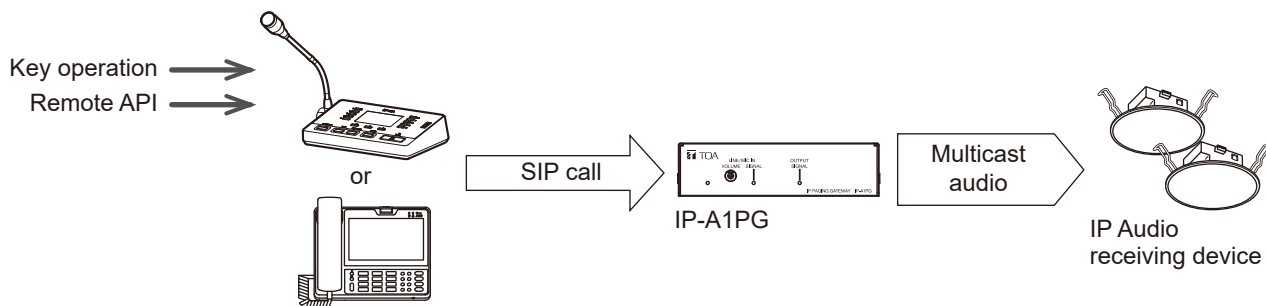

Example 3-3. Individual VMS Broadcasting to IP Audio receiving devices

When transmitting individual real time PA broadcasts from the VMS (Video Management System) software or a network recorder to each of the system's IP Audio receiving devices, enable VMS broadcasting by making a direct ONVIF connection to each IP Audio receiving device.



Example 3-4. PA (Public Address) Broadcasting from VMS software

When simultaneously transmitting PA broadcasts from the VMS software or a network recorder to multiple IP Audio receiving devices, enable multicast broadcasting using the IP Paging Gateway. When broadcasting from the VMS software, the multicast channels to be converted can be changed by designating the audio channel number to allow the broadcast destination groups to be switched.

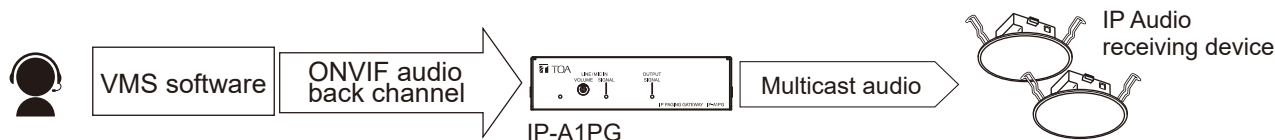

Note: ONVIF is the trademark of ONVIF Inc.

Example 3-5. PA (Public Address) Broadcasting from a microphone

When simultaneously broadcasting to multiple IP Audio receiving devices, enable PA broadcasting from a microphone connected to the IP Paging Gateway or from IP Remote Microphone.

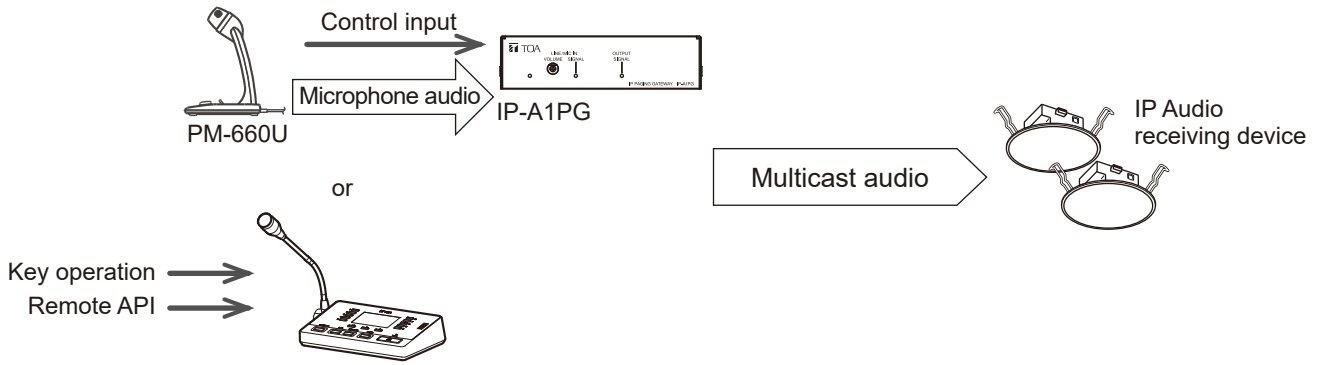

2.1.4. Broadcasting from recorded audio

Broadcast audio is first recorded to internal memory using the IP Remote Microphone, then broadcast.

Example 4-1. Individual SIP Broadcasting from recorded audio

In order to broadcast to each IP Audio receiving device, first establish a SIP connection directly to the intended IP Audio receiving device, then perform the recorded audio broadcast.

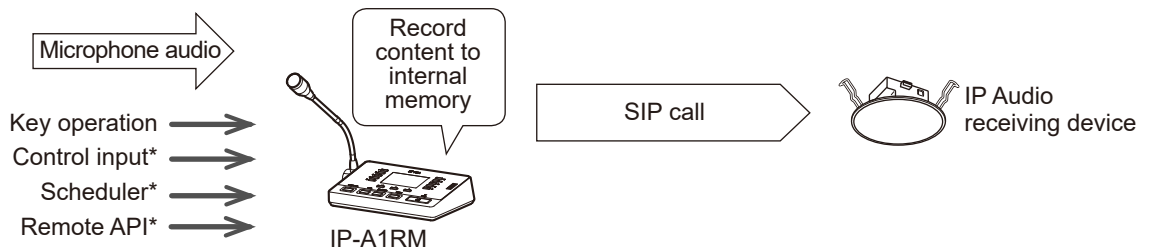

* Recorded audio can be pattern broadcast after first assigning the recording to a set pattern.

Example 4-2. Group Broadcasting from recorded audio

When simultaneously broadcasting to multiple IP Audio receiving devices, be sure to use only Multicast broadcasting.

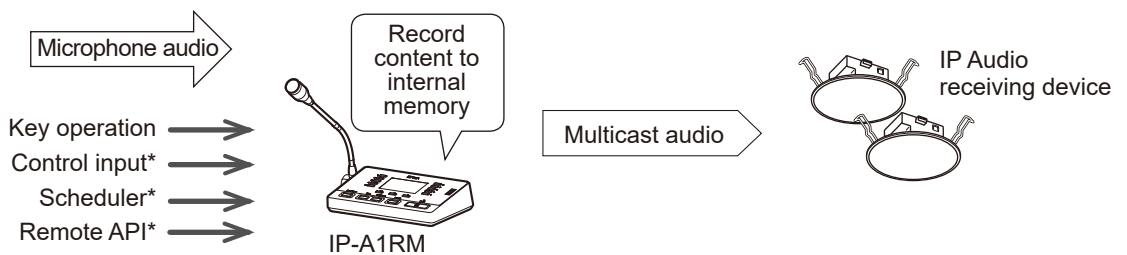

* Recorded audio can be pattern broadcast after first assigning the recording to a set pattern.

The broadcast system models can be summarized as follows:

| Broadcast Type | Sound Source | Forms of Broadcasts to Selected Broadcast Destinations | |
|---|------------------------------------|---|--|
| | | Individual Broadcasting | Group Broadcasting |
| Scheduled broadcast | Sound source file | Example 1-1. Broadcasting from the internal sound source of individual receiving devices* ¹ | Example 1-3. Group broadcasting from an internal sound source* ² |
| | | Example 1-2. Individual SIP broadcasting from the internal sound source* ² | |
| BGM broadcast | Analog audio | Example 2-1. Local broadcasting from the IP audio interface* ¹ | Example 2-3. Group broadcasting from analog sound sources* ² |
| | | Example 2-2. Individual SIP broadcasting from analog sound sources* ² | |
| Real time PA (public address) broadcast | SIP device (including the IP-A1RM) | Example 3-1. Individual SIP broadcasting to IP audio receiving devices* ² | Example 3-2. PA (public address) group broadcasting from a SIP device* ² |
| | VMS software | Example 3-3. Individual VMS broadcasting to IP audio receiving devices* ¹ | Example 3-4. PA (public address) broadcasting from VMS software* ² |
| | Microphone | Example 2-1. Local broadcasting from the IP audio interface* ¹ | Example 3-5. PA (public address) broadcasting from a microphone* ² |
| Broadcasting from recorded audio | Recorded audio | Example 4-1. Individual SIP broadcasting from recorded audio* ² | Example 4-2. Group broadcasting from recorded audio* ² |

*¹ In the models shown here, the receiving devices are used individually. Please refer to the following manual for the setting method:
 < Receiving Device Setup Manual >
 How to use the Broadcast Function

*² These models provide illustrations of the combined use of both transmitting and receiving devices. Please refer to the following manuals for the setting method:
 <Transmitting Device Setup Manual>
 Settings Flow by Model (p. 10)
 <Receiving Device Setup Manual>
 How to use the Broadcast Functions (Performing Multicast Broadcasting)

2.2. Settings Flow by Model

2.2.1. Example 1-2. Individual SIP broadcasting from the internal sound source

RM

To execute Individual SIP Broadcasting from the Internal Sound Source, which transmits a SIP-registered IP Remote Microphone sound source file, please perform the following settings.

Tip

This section describes the procedure for performing SIP broadcasts via a SIP server. If configuring settings via a P2P system, skip **Steps 1** and **9**.

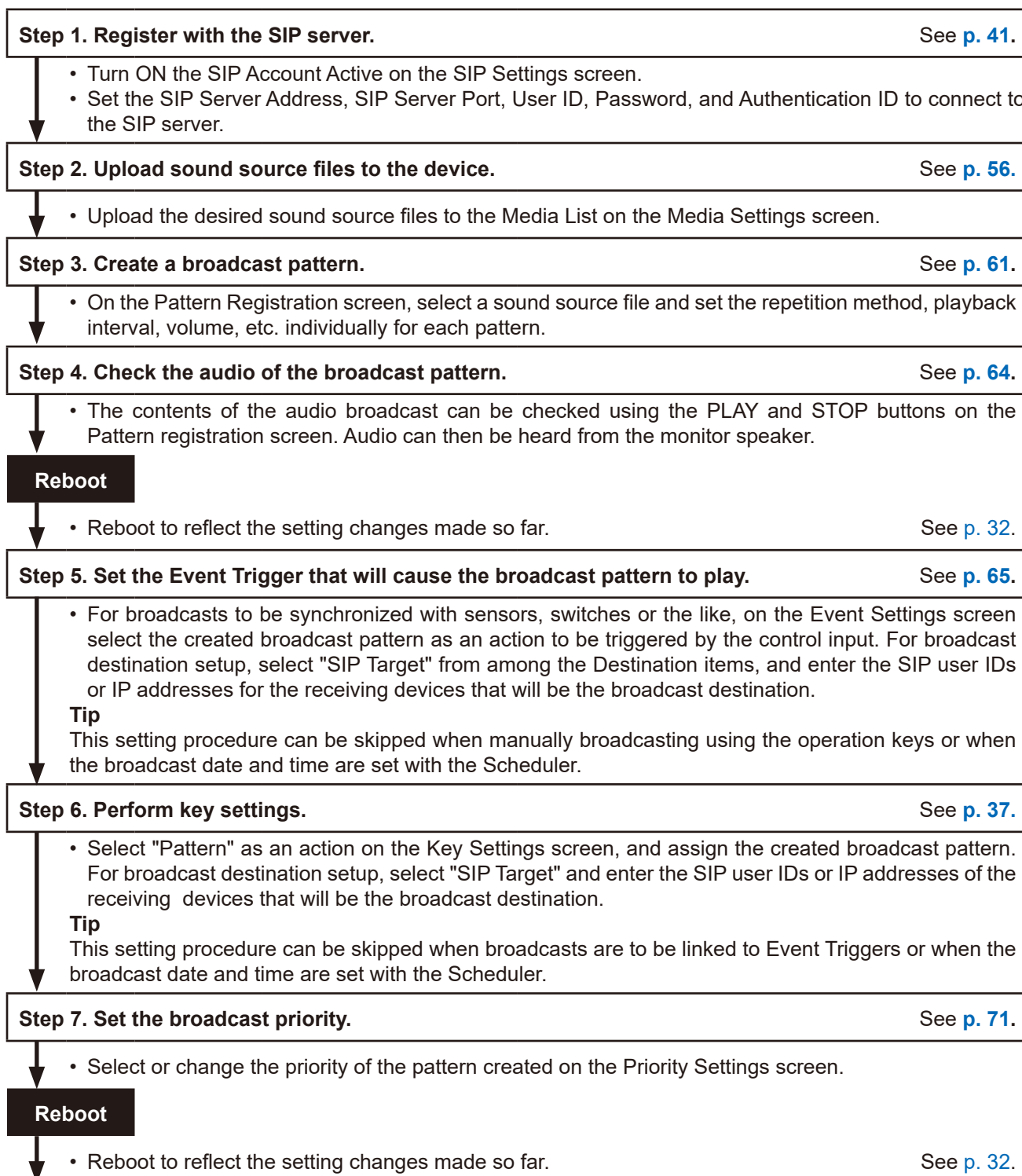

To the next page

From the previous page



Step 8. Create the broadcast schedule.

See [p. 93](#).

- To perform date and time-synchronized broadcasting, create the schedule that will execute the broadcast on the Scheduler screen.

Tip

This setting procedure can be skipped when broadcasting via manual operation using the operation keys or Event Triggers.

Step 9. Check the registration status on the SIP server.

See [p. 35](#), [p. 41](#).

- The broadcast is registered with the SIP server if the indication "Registered" is displayed in the SIP Registration Status field on the Status screen or in the SIP Account Active field on the SIP Settings screen.

Step 10. Check the audio to be transmitted.

- Execute the previously set Event Trigger, operation keys, or Scheduler, and confirm the audio coming from the IP Remote Microphone's monitor speaker.
- Additionally, confirm that the audio is being output from the receiving devices assigned to the SIP targets.
- To balance the sound output with that of other sound sources, adjust the Input Volume on the Pattern Registration screen. (See [p. 61](#).)

Tip

To adjust the volume of sound output coming from each speaker, perform adjustments to each receiving device separately.

2.2.2. Example 1-3. Group broadcasting from an internal sound source

To execute the internal sound source group broadcasting, which transmits the sound of the sound source file registered with the IP Audio transmitting device in the form of multicast audio, please perform the following settings:

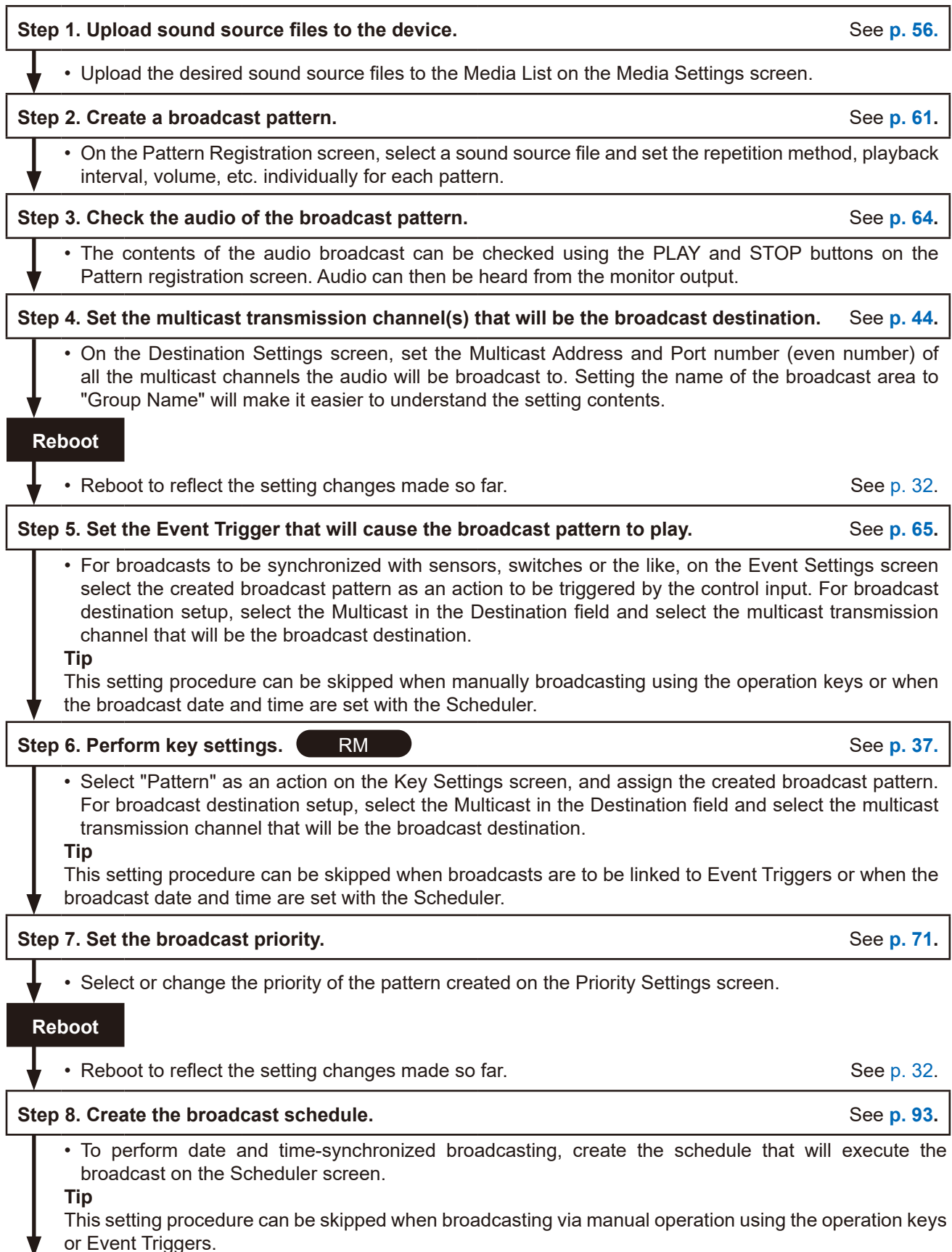

To the next page

From the previous page



Step 9. Check the audio to be transmitted.

- Execute the previously set Event Trigger, key operations, or Scheduler, and confirm the audio coming from the monitor output **PG** or monitor speaker **RM**.
- Additionally, confirm that the audio is being output from the receiving devices assigned to the multicast reception channel.
- To balance the sound output with that of other sound sources, adjust the Input Volume on the Pattern Registration screen. (See [p. 61.](#))

Tip

To adjust the volume of sound output coming from each speaker, perform adjustments to each receiving device separately.

To perform individual SIP broadcasting from analog sound sources from either an audio player connected to the IP Remote Microphone or the microphone, please perform the following settings.

Tip

This section describes the procedure for performing SIP broadcasts via a SIP server. If configuring settings via a P2P system, skip **Steps 1** and **6**.

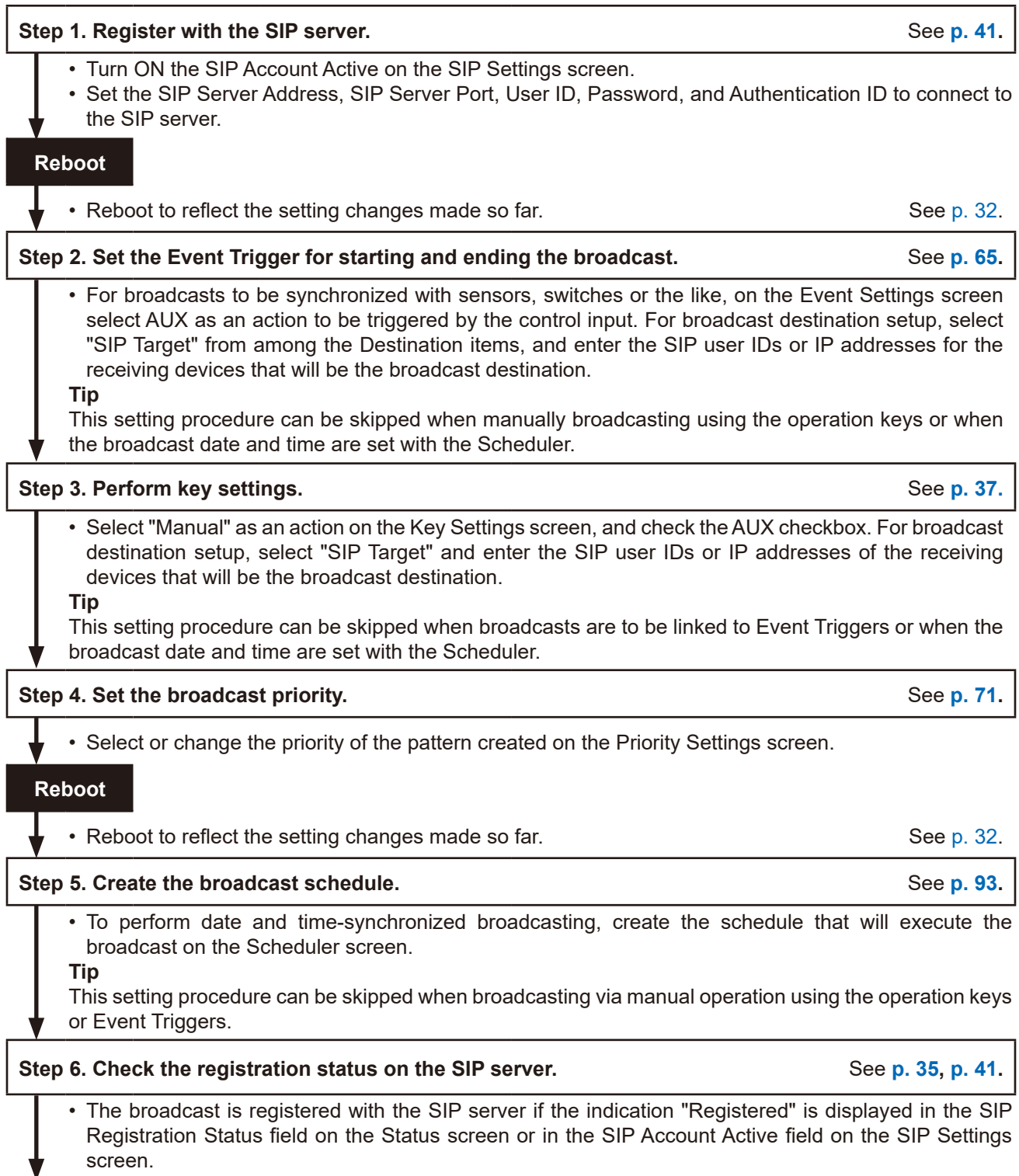

To the next page

From the previous page



Step 7. Check the audio to be transmitted.

- Execute the previously set Event Trigger, operation keys, or Scheduler, and confirm the audio coming from the IP Remote Microphones's monitor speaker.
- Additionally, confirm that the audio is being output from the receiving devices assigned to the SIP targets.
- To balance the sound output with that of other sound sources, adjust the input volume by the AUX volume control of the IP Remote Microphone.

Tip

To adjust the volume of sound output coming from each speaker, perform adjustments to each receiving device separately.

2.2.4. Example 2-3. Group broadcasting from analog sound sources and Example 3-5. PA (public address) broadcasting from a microphone

To perform group broadcasting from an analog sound source, or PA broadcasting from a microphone connected to the IP Audio transmitting device, which means transmitting the sound from these devices connected to the IP Audio transmitting device in the form of multicast audio, please perform the following settings:

Step 1. Set the multicast transmission channel(s) that will be the broadcast destination. See p. 44.

- On the Destination Settings screen, set the Multicast Address and Port number (even number) of all the multicast channels the audio will be broadcast to. Setting the name of the broadcast area to "Group Name" will make it easier to understand the setting contents.

Reboot

- Reboot to reflect the setting changes made so far. See p. 32.

Step 2. Set the Event Trigger for starting and ending the broadcast. See p. 65.

- If LINE/MIC IN **PG** or AUX **RM** is selected as the action of the control input on the Event Settings screen, broadcasting from the audio device connected to the LINE/MIC input terminal **PG** or AUX input jack **RM** can be performed in synchronization with the control input. For broadcast destination setup, select the Multicast in the Destination field and select the multicast transmission channel that will be the broadcast destination.

Tip

This setting procedure can be skipped when manually broadcasting using the operation keys or when the broadcast date and time are set with the Scheduler.

Step 3. Perform key settings. **RM** See p. 37.

- Select "Manual" as an action on the Key Settings screen, and check the AUX or Mic checkbox. For broadcast destination setup, select the Multicast in the Destination field and select the multicast transmission channel that will be the broadcast destination.

Tip

This setting procedure can be skipped when broadcasts are to be linked to Event Triggers or when the broadcast date and time are set with the Scheduler.

Step 4. Set the broadcast priority. See p. 71.

- Select or change the transmission priority for LINE MIC IN **PG**, or AUX or Microphone **RM** on the Priority Settings screen.

Reboot

- Reboot to reflect the setting changes made so far. See p. 32.

Step 5. Create the broadcast schedule. See p. 93.

- To perform date and time-synchronized broadcasting, create the schedule that will execute the broadcast on the Scheduler screen.

Tip

This setting procedure can be skipped when broadcasting via manual operation using the operation keys or Event Triggers.

Step 6. Check the audio to be transmitted.

- Execute the previously set Event Trigger, key operations, or Scheduler, and confirm the audio coming from the monitor output **PG** or monitor speaker **RM**.
- Additionally, confirm that the audio is being output from the receiving devices assigned to the multicast reception channel.

Tip

To adjust the volume of sound output coming from each speaker, perform adjustments to each receiving device separately.

To perform individual SIP broadcasting to IP Audio receiving devices from the microphone of the IP Remote Microphone via SIP, please perform the following settings.

Tip

This section describes the procedure for performing SIP broadcasts via a SIP server. If configuring settings via a P2P system, skip **Steps 1** and **4**.

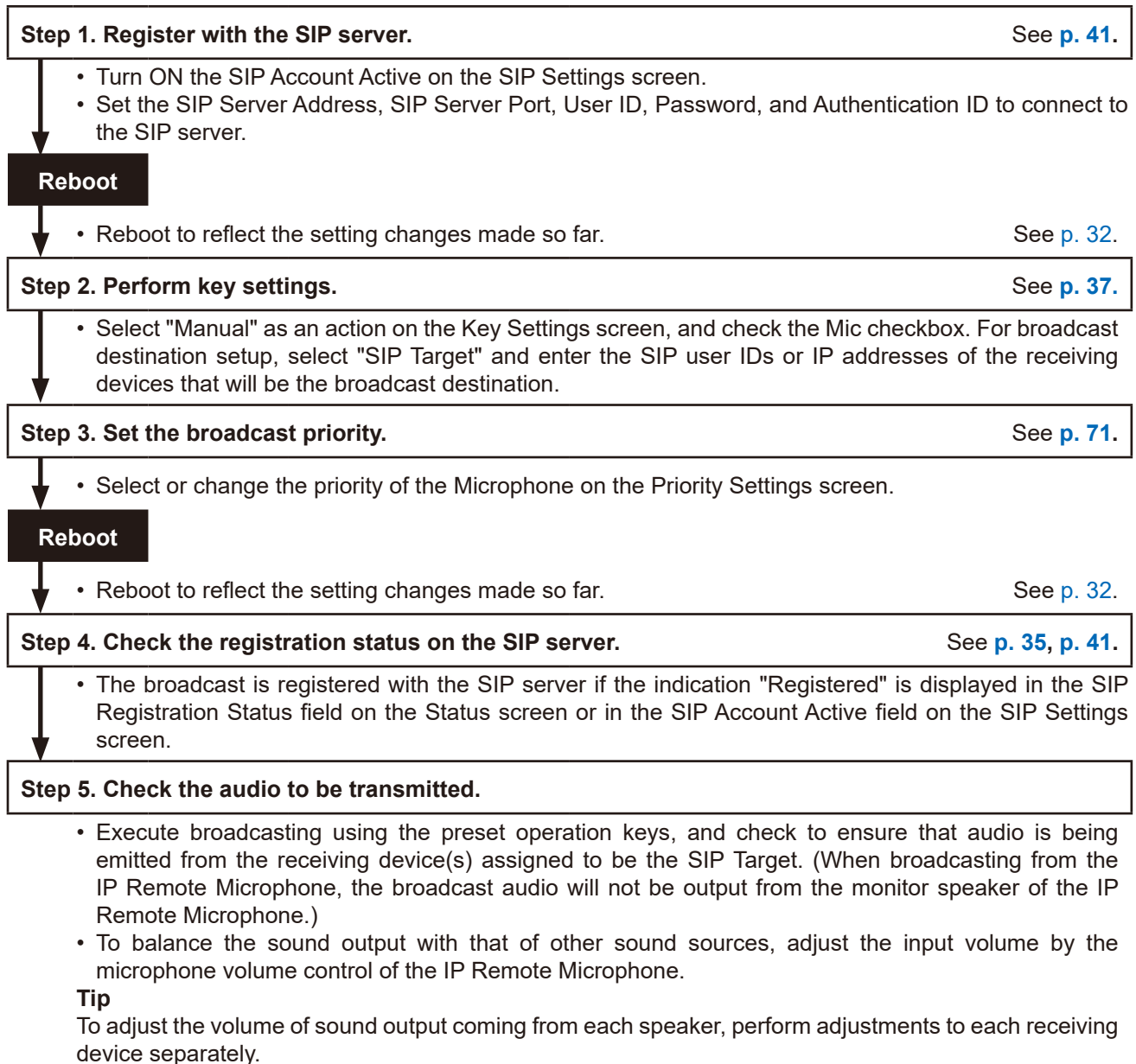

2.2.6. Example 3-2. PA (public address) group broadcasting from a SIP device

When calling the IP Paging Gateway from an IP Remote Microphone or SIP phone, the SIP device group PA broadcasting function, which transmits spoken voice as multicast audio, can be used.

Refer to the following procedure for system setup. For **Steps 1 – 4**, use the IP Paging Gateway. For **Steps 5 – 7**, use the IP Remote Microphone.

Tips

- This section describes the procedure for performing SIP broadcasts via a SIP server. If configuring settings via a P2P system, skip **Steps 1, 5, and 8**.
- When a SIP phone is the source, skip **Steps 5 – 7**.

[When connecting the DTMF numbers to multicast transmission channels]

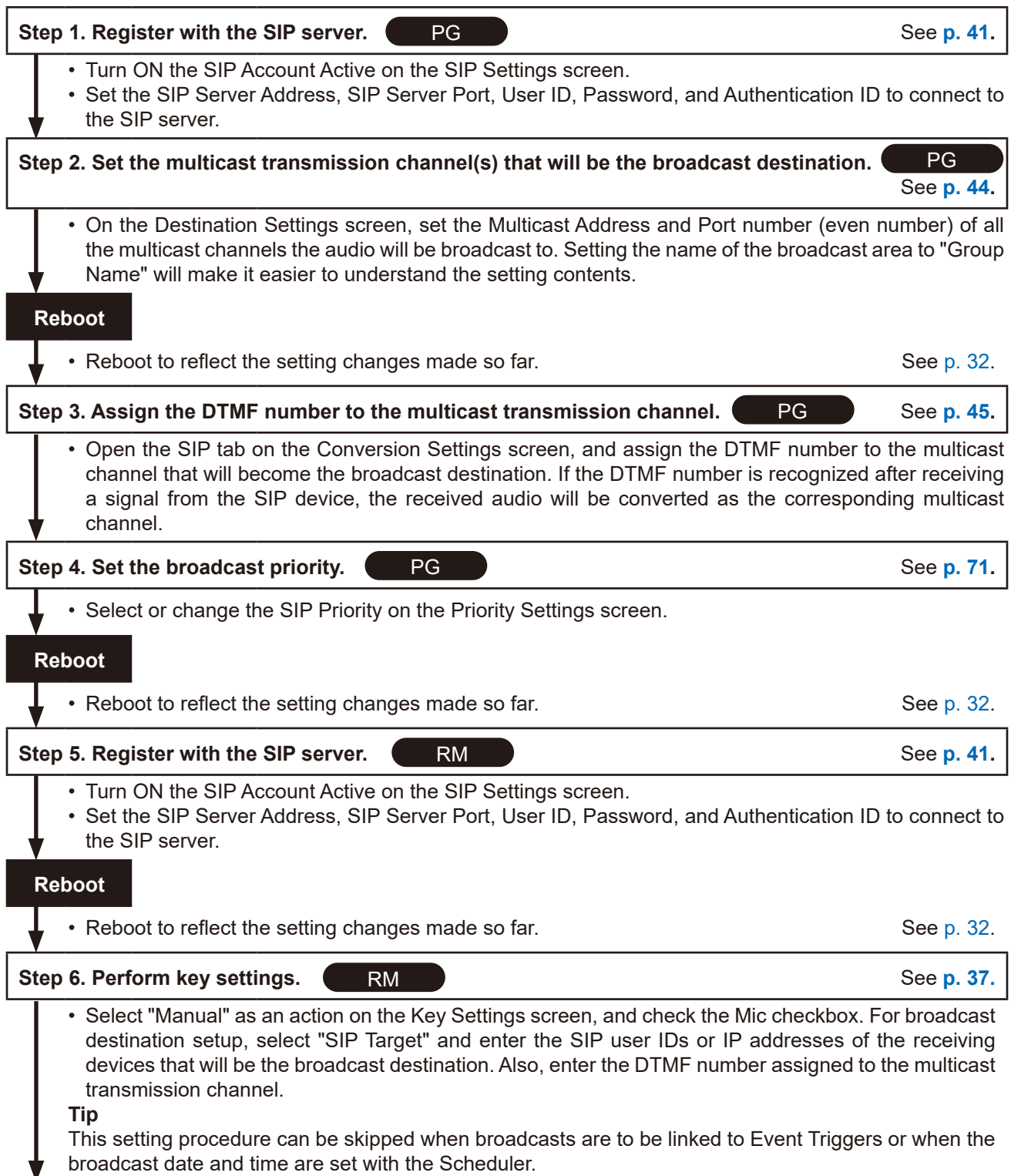

To the next page

From the previous page



Step 7. Set the broadcast priority.

RM

See [p. 71](#).



- Select or change the priority of the Microphone on the Priority Settings screen.

Reboot



- Reboot to reflect the setting changes made so far.

See [p. 32](#).

Step 8. Check the registration status on the SIP server.

See [p. 35](#), [p. 41](#).



- The broadcast is registered with the SIP server if the indication "Registered" is displayed in the SIP Registration Status field on the Status screen or in the SIP Account Active field on the SIP Settings screen.

Step 9. Check the audio to be transmitted.

- Call the IP Paging Gateway from an IP Remote Microphone or SIP phone. Transmission to the transmission multicast address assigned by the IP Paging Gateway is initiated by transmitting the DTMF number from the SIP phone after connection.
Always check to ensure that audio can be heard from the receiving device used to set the multicast reception channel (The DTMF number is automatically output when broadcasting from the IP Remote Microphone).
- To balance the sound output with that of other sound sources, adjust the input volume by the microphone volume control of the IP Remote Microphone.

Tip

To adjust the volume of sound output coming from each speaker, perform adjustments to each receiving device separately.

[When converting to a specific multicast transmission channel without using the DTMF number]

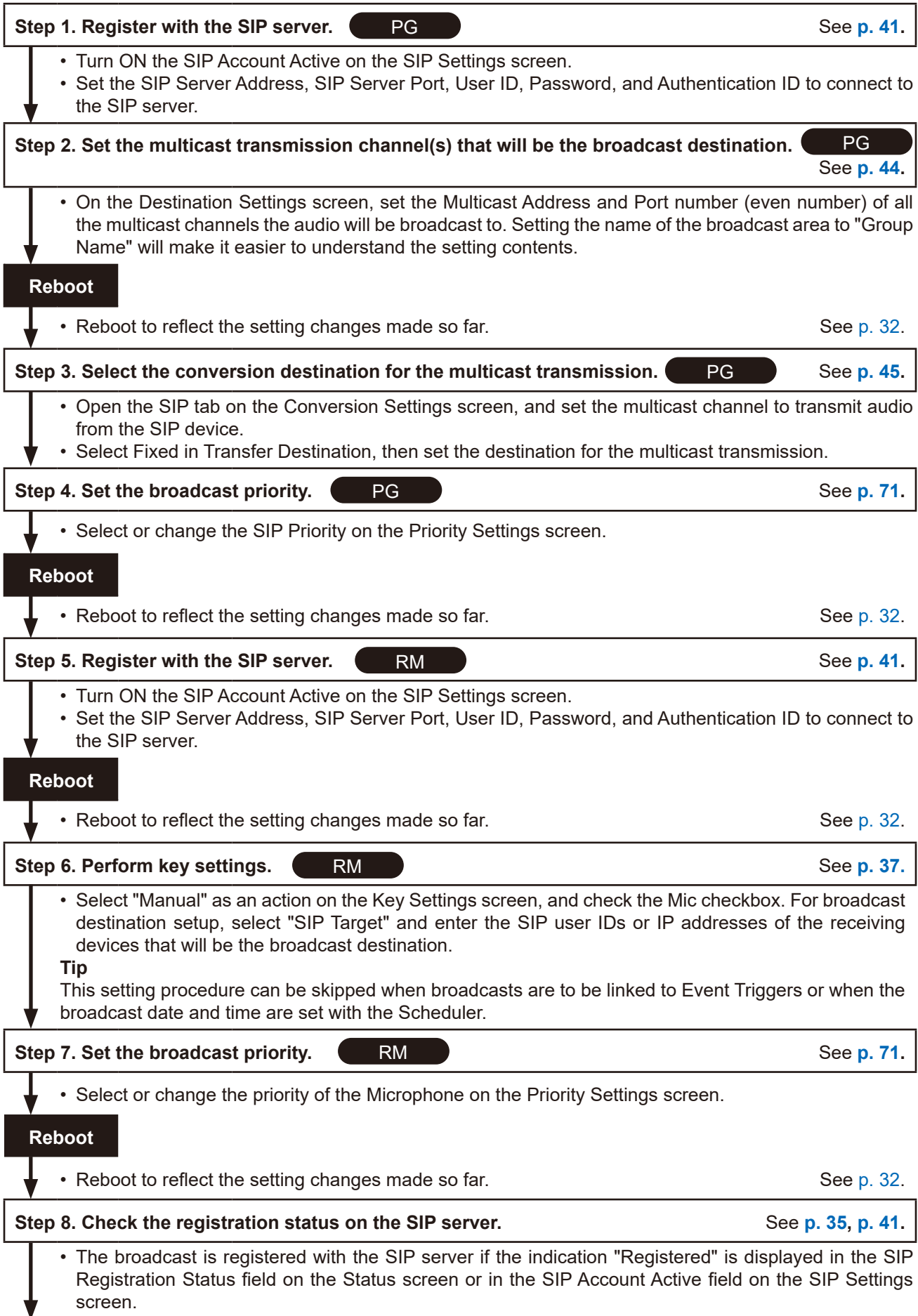

To the next page

From the previous page



Step 9. Check the audio to be transmitted.

- Call the IP Paging Gateway from an IP Remote Microphone or SIP phone.
- The converted multicast transmission begins immediately after connecting to the IP Paging Gateway. Always check to ensure that audio can be heard from the receiving device used to set the multicast reception channel
- To balance the sound output with that of other sound sources, adjust the input volume by the microphone volume control of the IP Remote Microphone.

Tip

To adjust the volume of sound output coming from each speaker, perform adjustments to each receiving device separately.

If the Transmitting Device is registered with or connected to a network recorder (NVR) or video management system (VMS), "PA Broadcasting from VMS Software" can be enabled so as to transmit audio from the microphone connected to the NVR or VMS clients as multicast audio. Please perform the following settings:

Step 1. Enable Detection, Registration & Connection of the device using the ONVIF protocol.

See [p. 43.](#)

- Turn ON the VMS Connection on the VMS Broadcasting Settings screen.
- Set the Control Port, RTSP Port, Username and Password to allow detection by or registration with the NVR or VMS clients.

Step 2. Set the multicast transmission channel(s) that will be the broadcast destination. See [p. 44.](#)

- On the Destination settings screen, set the Multicast Address and Port number (even number) of all the multicast channels the audio will be broadcast to. Setting the name of the broadcast area to "Group Name" will make it easier to understand the setting contents.

Reboot

- Reboot to reflect the setting changes made so far. See [p. 32.](#)

Step 3. Assign the audio channel to the multicast transmission channel.

See [p. 45.](#)

- Open the [VMS Broadcasting] tab on the Conversion Settings screen to assign an Audio Channel number to the multicast channel that will be designated as the broadcast destination. This allows the audio to be converted to the corresponding multicast channel, depending on which Audio Channel the VMS software selects to output the broadcast.

Step 4. Set the broadcast priority.

See [p. 71.](#)

- Select or change the priority of the VMS Broadcasts on the Priority Settings screen.

Reboot

- Reboot to reflect the setting changes made so far. See [p. 32.](#)

Step 5. Register the device with or connect it to NVR or VMS as an ONVIF device.

- Refer to the NVR or VMS instruction manual for more details on detecting, registering or connecting the ONVIF device.

Step 6. Adjust the broadcast volume.

- Operate the NVR or VMS client to start the broadcast using a microphone, and confirm that audio is being output from the transmitting device's monitor.
- Additionally, confirm that the audio is being output from the receiving devices assigned to the multicast reception channel.

Tip

To adjust the volume of sound output coming from each speaker, perform adjustments to each receiving device separately.

Refer to the following procedure when performing "Individual SIP Broadcasting from recorded audio" to the device. This procedure is divided into two parts: "Manual broadcasting by operation key" and "Scheduler- or event-triggered broadcasts of a pre-registered recorded audio file."

[Manual broadcasting by operation key]

Tip

This section describes the procedure for performing SIP broadcasts via a SIP server. If configuring settings via a P2P system, skip **Steps 1** and **4**.

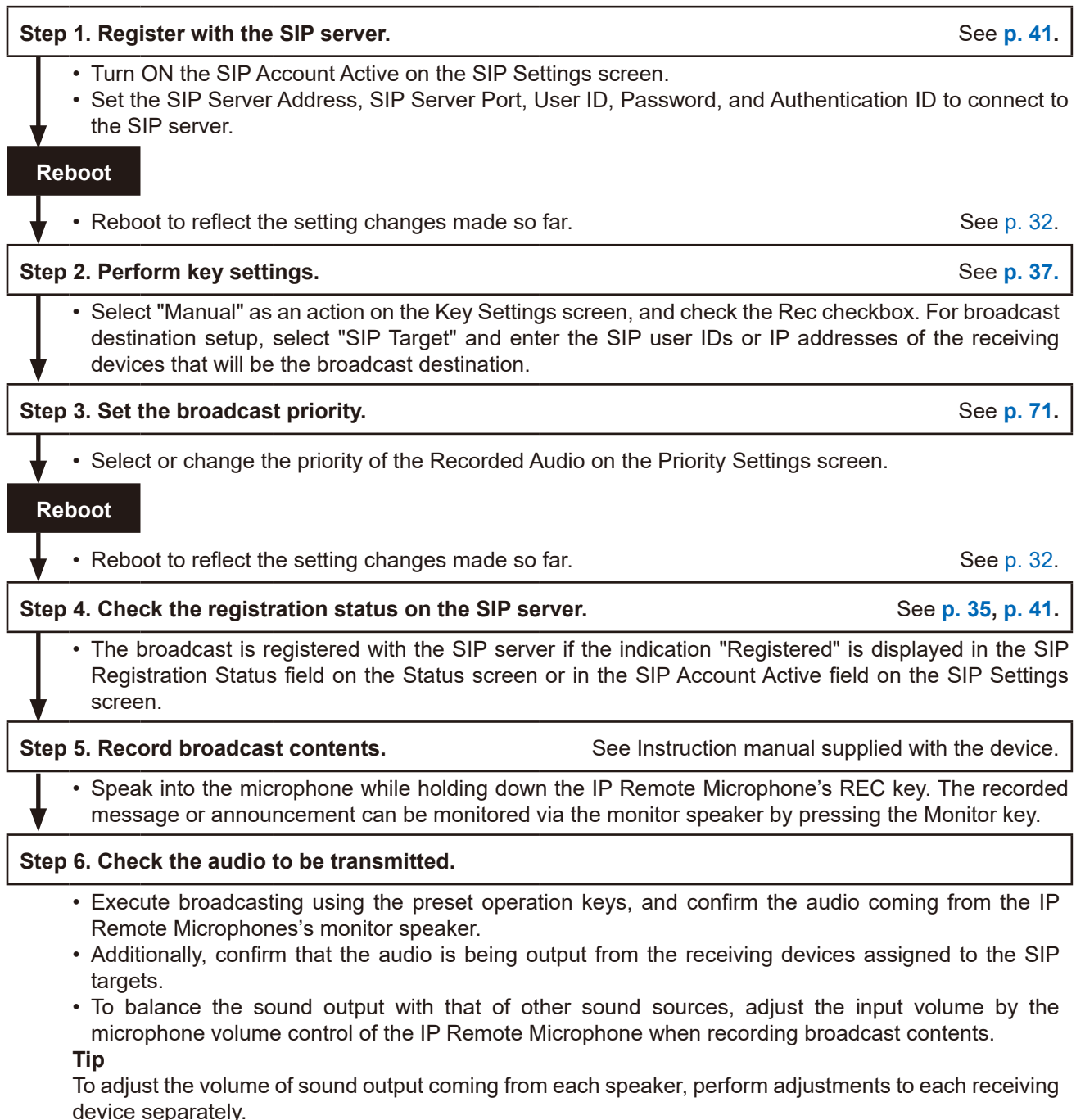

[Scheduler- or event-triggered broadcasts of a pre-registered recorded audio file]

Tip

This section describes the procedure for performing SIP broadcasts via a SIP server. If configuring settings via a P2P system, skip **Steps 1** and **6**.

| | |
|---|---|
| Step 1. Register with the SIP server. | See p. 41 . |
| <ul style="list-style-type: none">• Turn ON the SIP Account Active on the SIP Settings screen.• Set the SIP Server Address, SIP Server Port, User ID, Password, and Authentication ID to connect to the SIP server. | |
| Step 2. Create a broadcast pattern. | See p. 61 . |
| <ul style="list-style-type: none">• On the Pattern Registration screen, select a recorded audio file and create a broadcast pattern to set the repetition method, playback interval, volume, etc. individually for each pattern. | |
| Reboot | |
| <ul style="list-style-type: none">• Reboot to reflect the setting changes made so far. | |
| Step 3. Set the Event Trigger that will cause the broadcast pattern to play. | See p. 65 . |
| <ul style="list-style-type: none">• For broadcasts to be synchronized with sensors, switches or the like, on the Event Settings screen select the created broadcast pattern as an action to be triggered by the control input. For broadcast destination setup, select the SIP Target in the Destination field and enter the SIP user IDs or IP addresses that will be the broadcast destination. | |
| Tip This setting procedure can be skipped when the broadcast date and time are set with the Scheduler. | |
| Step 4. Set the broadcast priority. | See p. 71 . |
| <ul style="list-style-type: none">• Select or change the priority of any broadcast patterns made up of preregistered recorded audio on the Priority Settings screen. | |
| Reboot | |
| <ul style="list-style-type: none">• Reboot to reflect the setting changes made so far. | |
| Step 5. Create the broadcast schedule. | See p. 93 . |
| <ul style="list-style-type: none">• To perform date and time-synchronized broadcasting, create the schedule that will execute the broadcast on the Scheduler screen. | |
| Tip This setting procedure can be skipped when broadcasting via Event Triggers. | |
| Step 6. Check the registration status on the SIP server. | See p. 35 , p. 41 . |
| <ul style="list-style-type: none">• The broadcast is registered with the SIP server if the indication "Registered" is displayed in the SIP Registration Status field on the Status screen or in the SIP Account Active field on the SIP Settings screen. | |
| Step 7. Record broadcast contents. | See Instruction manual supplied with the device. |
| <ul style="list-style-type: none">• Speak into the microphone while holding down the IP Remote Microphone's REC key. The recorded message or announcement can be monitored via the monitor speaker by pressing the Monitor key. | |
| Step 8. Check the audio to be transmitted. | |
| <ul style="list-style-type: none">• Execute broadcasting using the previously set Event Trigger or Scheduler, and confirm the audio coming from the IP Remote Microphones's monitor speaker.• Additionally, confirm that the audio is being output from the receiving devices assigned to the SIP targets.• To balance the sound output with that of other sound sources, adjust the input volume by the microphone volume control of the IP Remote Microphone when recording broadcast contents. | |
| Tip To adjust the volume of sound output coming from each speaker, perform adjustments to each receiving device separately. | |

Refer to the following procedure when performing "Group Broadcasting from recorded audio" to the device using multicast. This procedure is divided into two parts: "Manual broadcasting by operation key" and "Scheduler- or event-triggered broadcasts of a pre-registered recorded audio file."

[Manual broadcasting by operation key]

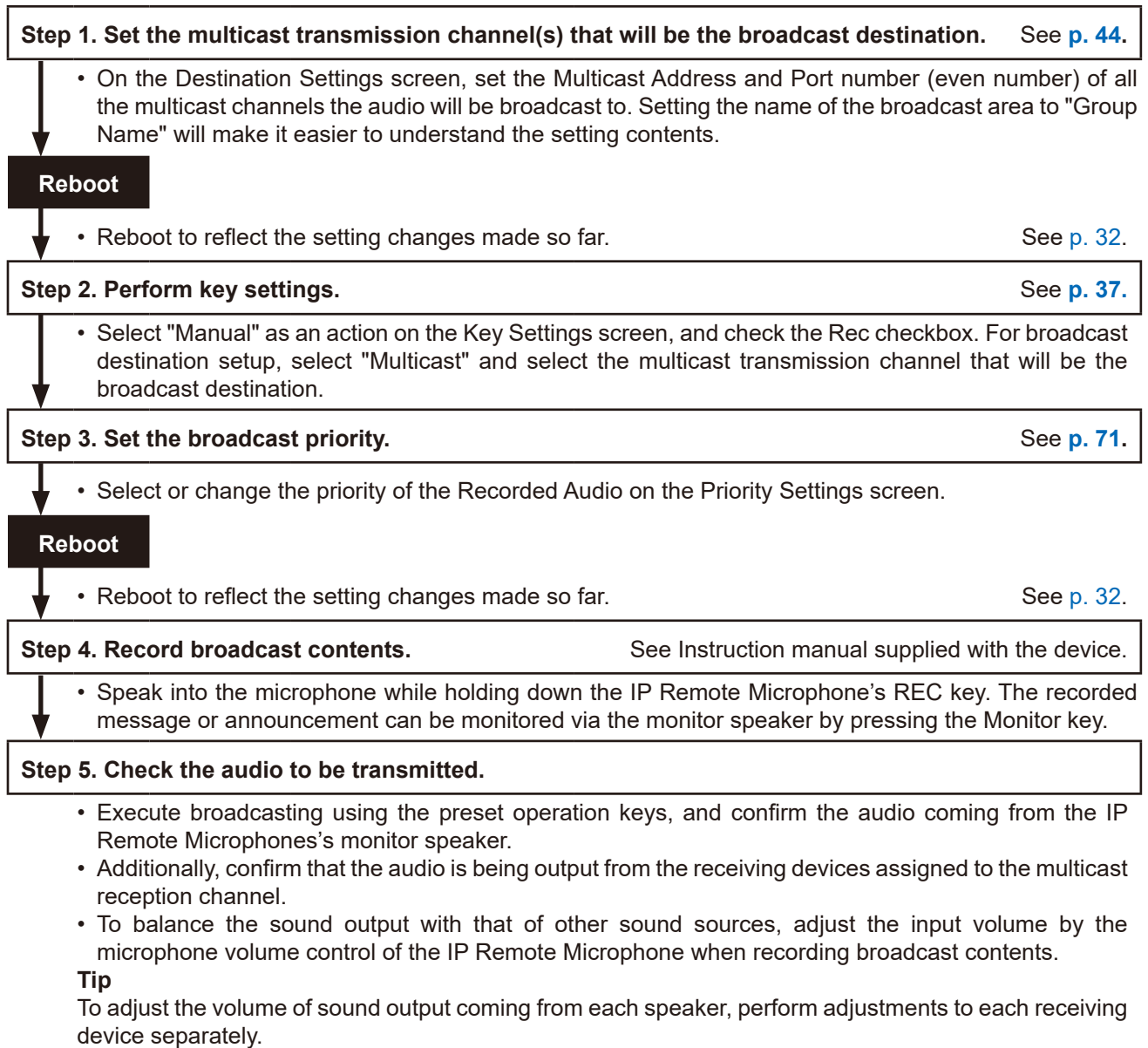

[Broadcasting recorded audio as a broadcast pattern]

Step 1. Create a broadcast pattern.

See [p. 61.](#)

- On the Pattern Registration screen, select a recorded audio file and create a broadcast pattern to set the repetition method, playback interval, volume, etc. individually for each pattern.

Step 2. Set the multicast transmission channel(s) that will be the broadcast destination.

See [p. 44.](#)

- On the Destination Settings screen, set the Multicast Address and Port number (even number) of all the multicast channels the audio will be broadcast to. Setting the name of the broadcast area to "Group Name" will make it easier to understand the setting contents.

Reboot

- Reboot to reflect the setting changes made so far.

See [p. 32.](#)

Step 3. Set the Event Trigger that will cause the broadcast pattern to play.

See [p. 65.](#)

- For broadcasts to be synchronized with sensors, switches or the like, on the Event Settings screen select the created broadcast pattern as an action to be triggered by the control input. For broadcast destination setup, select the Multicast in the Destination field and select the multicast transmission channel that will be the broadcast destination.

Tip

This setting procedure can be skipped when the broadcast date and time are set with the Scheduler.

Step 4. Set the broadcast priority.

See [p. 71.](#)

- Select or change the priority of any broadcast patterns made up of preregistered recorded audio on the Priority Settings screen.

Reboot

- Reboot to reflect the setting changes made so far.

See [p. 32.](#)

Step 5. Create the broadcast schedule.

See [p. 93.](#)

- To perform date and time-synchronized broadcasting, create the schedule that will execute the broadcast on the Scheduler screen.

Tip

This setting procedure can be skipped when broadcasting via Event Triggers.

Step 6. Record broadcast contents.

See Instruction manual supplied with the device.

- Speak into the microphone while holding down the IP Remote Microphone's REC key. The recorded message or announcement can be monitored via the monitor speaker by pressing the Monitor key.

Step 7. Check the audio to be transmitted.

- Execute broadcasting using the previously set Event Trigger or Scheduler, and confirm the audio coming from the IP Remote Microphones's monitor speaker.
- Additionally, confirm that the audio is being output from the receiving devices assigned to the multicast reception channel.
- To balance the sound output with that of other sound sources, adjust the input volume by the microphone volume control of the IP Remote Microphone when recording broadcast contents.

Tip

To adjust the volume of sound output coming from each speaker, perform adjustments to each receiving device separately.

3. CONNECTION WITH BROWSER

3.1. Connection Presets

The device is factory-preset as follows:

Username: admin
Password: guest
IP address: 192.168.14.1
Subnet mask: 255.255.255.0
Default gateway: 0.0.0.0

Before connecting a PC to the device and changing its setting, it will be necessary to set the PC's network settings so that it can operate on the same network as the device. Take care that no IP addresses are duplicated in the same network. For example, if the device's IP address is 192.168.14.1, set the PC's IP address to 192.168.14.10 or the like.

3.2. Making Connection

Notes

- Avoid simultaneously connecting to the device from multiple PCs.
- Avoid simultaneously connecting to the device from a single PC using multiple browsers.

Step 1. Connect both the device and the PC to be used for setup to the network.

Step 2. Start the PC's browser and enter the device's IP address in the address field.

Example: 192.168.14.1

The Login screen will be displayed.

Tip

Default IP address: 192.168.14.1

Step 3. Enter both the username and the password, and click on the LOGIN button.

The Status screen will be displayed.

Click on the individual function names arranged on the left side of the browser screen to switch screens and perform the required settings for each selected screen.

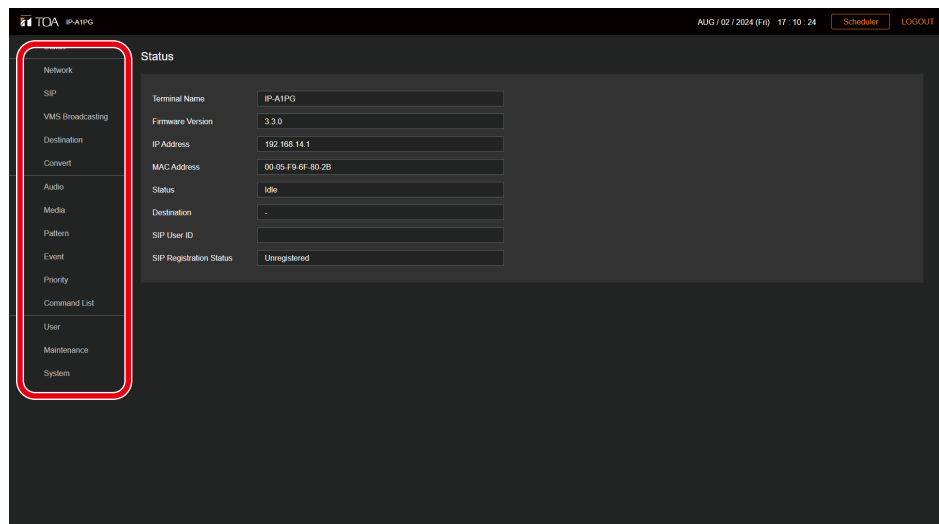
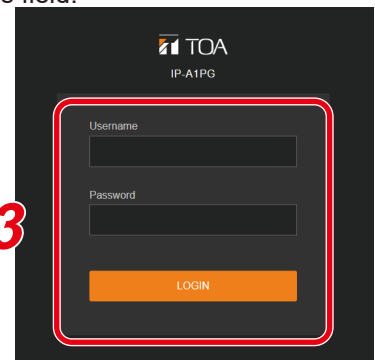

4. CURRENT DATE AND TIME SETTINGS

Before beginning to use the device, be sure that the current date and time are correctly set. This initial setting is required in order to accurately set and operate the device's Scheduler or confirm its logs. First go to the System settings screen to perform these settings (p. 88).

Note

When the device is used for the first time or has not been powered for long periods of time, the message below is displayed.

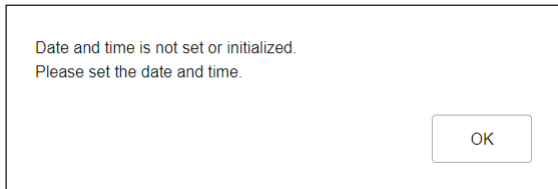

In such cases, set the current date and time using one of the following procedures.

4.1. Automatic Date and Time Synchronization with the NTP Server

Step 1. Switch ON NTP and designate the NTP server to be used to synchronize the date and time.

Up to two different NTP servers can be set. Enter the IP address or domain for NTP Servers 1 and 2. NTP Server 1 takes precedence and will be synchronized first.

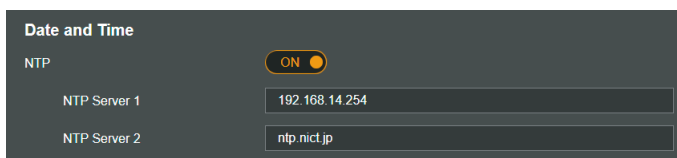

Step 2. Select the Time Zone.

Select the Time Zone of the location where the device is installed.

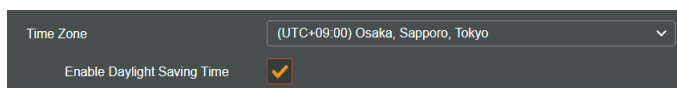

Step 3. Click on the SAVE button.

Any changes to the settings are saved while the date and time are simultaneously synchronized with the NTP server. If synchronization is successful, the indication "Synchronized" is displayed.

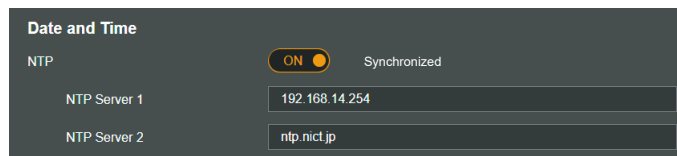

Tips

- This device can be synchronized with an NTP server when NTP is switched ON and...
 - The SAVE button is clicked.
 - The device is restarted.
 - The device's clock is synchronized everyday at 00:01.
- However, no synchronization is possible if the receiving device is currently broadcasting.
- If a broadcast is in progress when the SAVE button is clicked, the reflection of clock setting is given priority and the currently in-progress broadcast is terminated.

4.2. Synchronization with a Connected PC's Clock (Date and Time)

Step 1. Switch ON Sync with PC.

Settings can be changed when the NTP function is switched OFF.



Step 2. Select the Time Zone.

Select the Time Zone of the location where the device is installed.

Step 3. Click on the SAVE button.

Any changes to the settings are saved while the date and time are simultaneously synchronized with the PC displaying the setting screen. Note that synchronization is only performed once, and not on a regular basis.

Note

If the SAVE button is clicked on while a broadcast is taking place, the time setting will take precedence, causing the current broadcast to stop.

4.3. Manual Date and Time Settings

Step 1. Enter the current date and time in the Manual Setting box.

When both NTP and Sync with PC are set to OFF, the date and time can be entered manually.

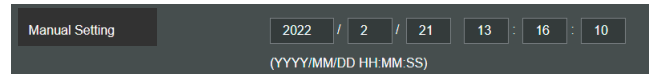

The image shows a 'Manual Setting' interface with a dark background. On the left is a button labeled 'Manual Setting'. To its right are input fields for date and time. The date fields are '2022', '/', '2', '/', '21'. The time fields are '13', ':', '16', ':', '10'. Below these fields is the text '(YYYY/MM/DD HH:MM:SS)'.

Step 2. Select the Time Zone.

Select the Time Zone of the location where the device is installed.

Step 3. Click on the SAVE button.

The entered date and time are saved.

Note

If the SAVE button is clicked on while a broadcast is taking place, the time setting will take precedence, causing the current broadcast to stop.

5. OPERATIONS COMMON TO EACH SCREEN

5.1. Screen Layout

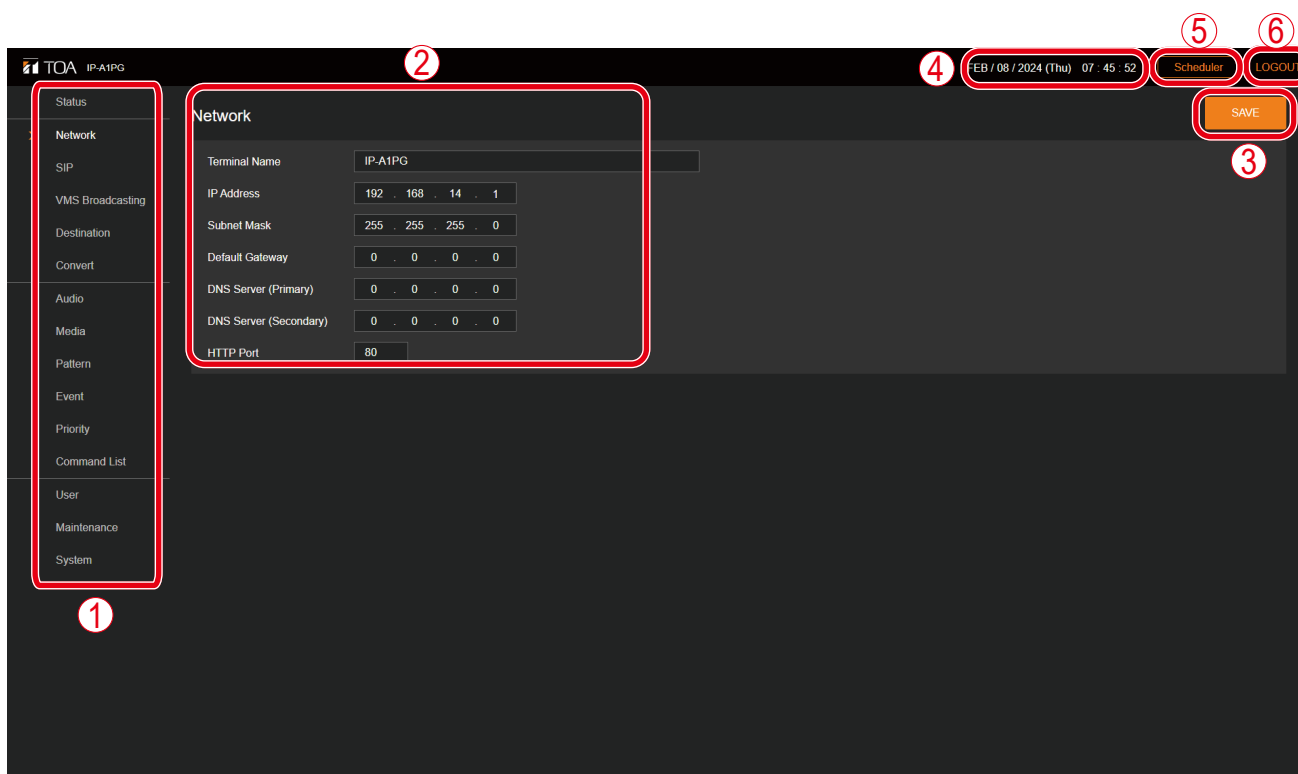

| | Name | Description |
|-----|----------------------|--|
| (1) | Settings Menu | Clicking on the Settings menu automatically switches the screen to the Setting Items window. If a setting item is changed, click on the SAVE button to save the changed contents before switching from the Setting Items window. |
| (2) | Setting Items Window | Displays the setting items for each Settings menu. If a setting item is changed, click on the SAVE button to save the changed contents before switching from the Setting Items window. |
| (3) | SAVE button | Saves the changed setting contents. |
| (4) | Current Time Display | Displays the built-in clock's current time. |
| (5) | Scheduler button | Switches the screen over to the Scheduler screen. Schedules of broadcasts or actions can be set here. |
| (6) | LOGOUT Button | Click this button to log out only after confirming completion of setting contents entry or changes. The Logout screen is displayed after logging out. |

5.2. Saving Settings or Changed Contents

If any setting items are changed, these changes need to be saved. Note that there may be cases where settings or changes are applied immediately or only after restarting the device.

5.2.1. Cases in which settings or changes are immediately applied

Step 1. Click on the SAVE button.

The message at right appears, notifying the user that the setting or change has been immediately applied:

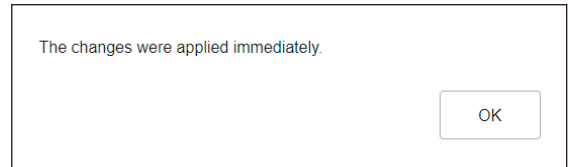

Step 2. Click on the OK button.

5.2.2. Cases in which settings or changes are only applied after device restart

Step 1. Click on the SAVE button.

The message at right appears, notifying the user that the changed contents will only be applied after device restart.

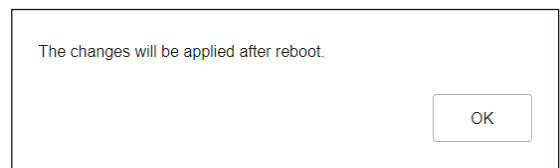

Step 2. Click on the OK button.

Step 3. Move to the Maintenance screen and click on REBOOT.



Note

Attempting to switch screens without clicking on the SAVE button after changes are made to the settings or contents of each screen (Status screen, Media Settings screen and Maintenance screen excepted) will cause the screen at right to appear:

- If saving changes made to the setting contents of a screen, first click on the NO button, then the SAVE button, before switching screens.
- If not saving changes made to the setting contents, click on the YES button. The display will switch to another screen without saving the contents.

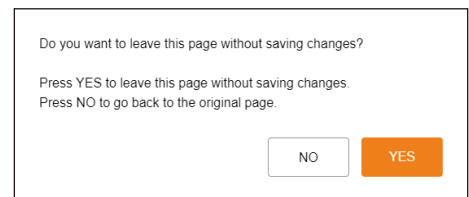

5.3. Restarting the Device

The procedure for restarting (or rebooting) the device is as follows:

Step 1. Move to the Maintenance screen.



Step 2. Click on the REBOOT button.
A confirmation dialog box is displayed.

Step 3. Click on the YES button.
The network connection with the device is disconnected, causing the device to automatically restart.

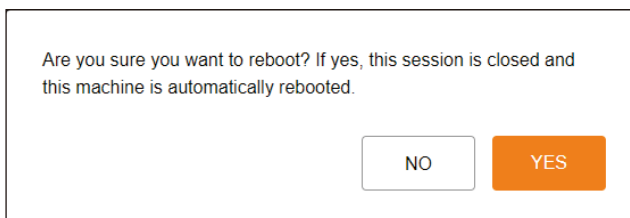

5.4. Logging Out

LOGOUT button



To terminate the network connection after completing confirmation or changes to the device's settings, click on the LOGOUT button.

When logged out, the Login screen will be displayed.

6. SETTINGS

6.1. About the Setting Menu Composition of Each Model

The setting menu to be displayed on the left side of the screen differs depending on the model.

IP-A1PG, IP-A1RM



IP-A1PG

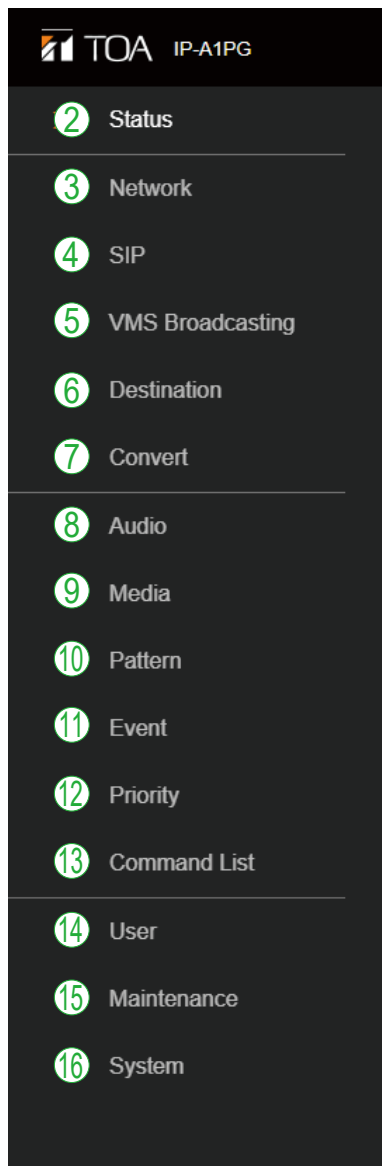

IP-A1RM

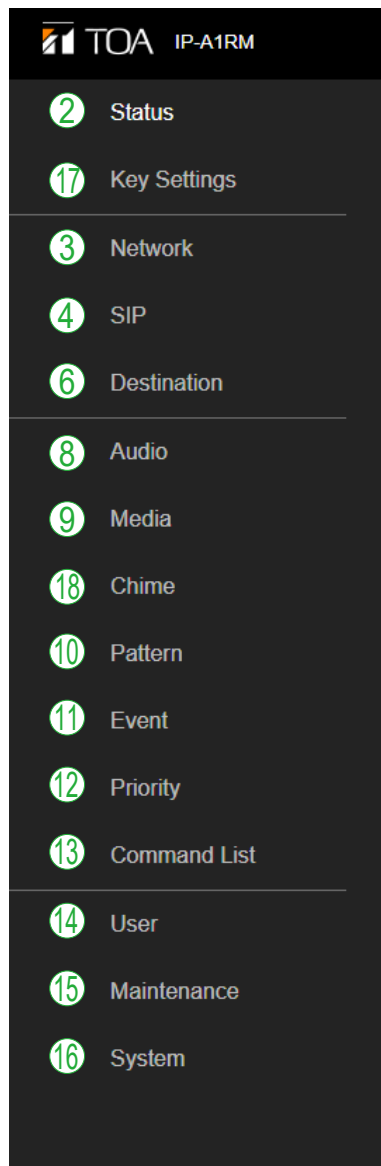

| | Setting Name | Setting Item | Application of setting changes | Page |
|------|---|---|--------------------------------|-----------------------|
| (1) | Scheduler | Registration, editing, and deletion of programmed repeat broadcast schedule and event execution, display of schedules for one week, check the annual schedule | Immediately | p. 93 |
| (2) | Status screen | Confirmation of current firmware version, network settings, volume setting | — | p. 35 |
| (3) | Network Settings screen | Network settings such as the IP address | After restart | p. 40 |
| (4) | SIP Settings screen | Settings of SIP connection enable/disable, SIP server address, authentication information, and audio codec | After restart | p. 41 |
| (5) | VMS Broadcasting Settings screen PG | Settings of VMS connection enable/disable and authentication information, connection port settings | After restart | p. 43 |
| (6) | Destination Settings screen | Settings of multicast destination group name, multicast address and port number | After restart | p. 44 |
| (7) | Conversion Settings screen PG | Settings of the broadcast destination selection method (DTMF/Fixed) to be used for incoming SIP calls, and settings of the corresponding relationship between audio channels and broadcast destinations when connected to the VMS | After restart | p. 45 |
| (8) | Audio Settings screen | Settings of Line/Mic input sensitivity and mute PG Microphone sensitivity and AUX sensitivity/mute settings RM | Immediately | p. 52 |
| (9) | Media Settings screen | Uploading/downloading or deletion of sound source files such as messages to or from the internal memory | — | p. 56 |
| (10) | Pattern Registration screen | Registration of sound source playback to be associated with events as patterns | Immediately | p. 61 |
| (11) | Event Settings screen | Settings of operations to be synchronized with the control input and control output | After restart | p. 65 |
| (12) | Priority Settings screen | Settings of priority order for each broadcast sound sources. | After restart | p. 71 |
| (13) | Command List screen | Settings of HTTP commands in command sets | Immediately | p. 74 |
| (14) | User Settings screen | Changing username and password | Immediately | p. 76 |
| (15) | Maintenance screen | Download and upload the configuration file, initialization, firmware update, hardware reboot, and downloading action logs | — | p. 77 |
| (16) | System Settings screen | Date and time settings, NTP server settings, Time zone settings, and language setting | Immediately* | p. 88 |
| (17) | Key Settings screen RM | Operation key function assignment and broadcast destination selection, etc. | Immediately | p. 37 |
| (18) | Chime Settings screen RM | Broadcast start/end chime selection | Immediately | p. 60 |

* Changes to the IP-A1RM Remote Microphone's screen display language are only reflected after restart.

7. STATUS SCREEN DISPLAY

This screen displays the device's state.



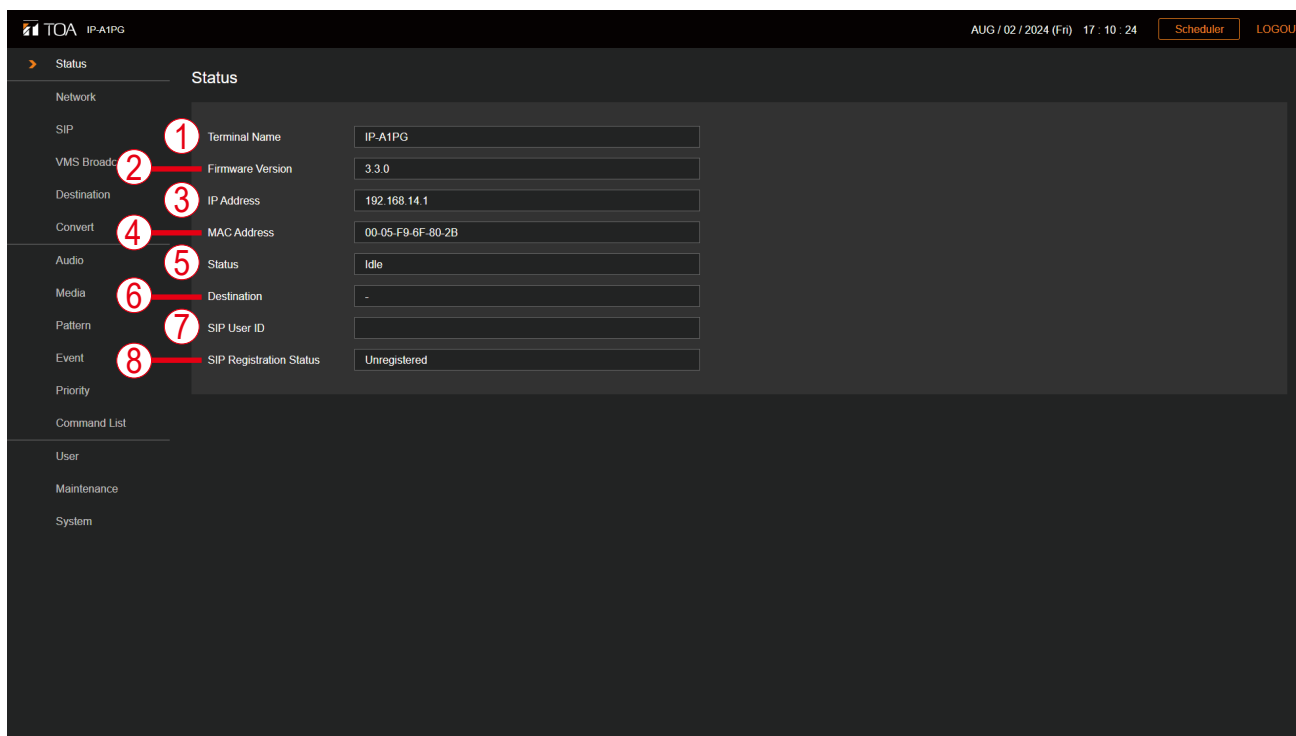





Since this page only displays the current settings, the contents cannot be changed on this page.



| | Item | Contents |
|-----|-------------------------|--|
| (1) | Terminal Name | Displays the device name set on the Network settings screen (p. 40). |
| (2) | Firmware Version | Displays the device's current firmware version. (See "Firmware Update" on p. 82.) |
| (3) | IP Address | Displays the device's IP address set on the Network settings screen (p. 40). |
| (4) | MAC Address | Displays the device's MAC address. |
| (5) | Status | Displays the device's operating status. (See "Status Screen and Status Indicators" on p. 36.) |
| (6) | Destination | Indicates which multicast transmission channel is currently being broadcast. The group name of each multicast transmission channel set on the Destination screen is displayed. —: The operating state when no broadcasting is being performed. Group Name: Audio currently transmitting to the displayed broadcast destination(s). |
| (7) | SIP User ID | Displays the device's name when registering the device on the SIP server. (See "SIP SETTINGS SCREEN" on p. 41.) |
| (8) | SIP Registration Status | Displays the device's registration status when registering it on a SIP server. (See "SIP SETTINGS SCREEN" on p. 41.) Registered: Registration successful. Registration Failed: Registration failed. Registering: Registration in progress. Unregistered: Registration invalid. |

7.1. Status Screen and Status Indicators

Display of Status items on the Status screen and status indicators (Status LED) have the following relationship:

| Device operation | Status display on the Status screen | Microphone indicator | Status indicator (Status LED) |
|---|--|--|--|
| | | IP-A1RM (Blue) | IP-A1PG, IP-A1RM (Green, Blue, Yellow, Red) |
| System startup | — | Unlit | Flashing green  |
| Broadcast standby | Idle | Unlit | Continuously lit green  |
| Audio source now being monitored RM | Idle | Unlit | Continuously lit green  |
| Audio source now being recorded RM | Idle | Continuously lit blue  | Continuously lit green  |
| Broadcasting | PG SIP DTMF waiting SIP to Multicast VMS to Multicast Pattern ## (sound source filename) to Multicast LINE/MIC IN to Multicast | — | Continuously lit blue  |
| | RM Microphone to SIP Calling Microphone to SIP Microphone to Multicast | Continuously lit blue  | |
| | RM AUX to SIP AUX to Multicast Recorded Audio to SIP Calling Recorded Audio to SIP Recorded Audio to Multicast Pattern ## (sound source filename) to SIP Pattern ## (sound source filename) to Multicast | Unlit | |
| System mute* | System Mute | Unlit | Flashing red  |
| Initialization or firmware updating | — | Unlit | Continuously lit yellow  |

* "System mute" represents the state that the broadcast audio sent out from the transmitting device is suspended and at the same time, IP speakers in the same network are muted by the signal from transmitting device. "System mute" is activated by mute terminal or control input terminal.

8. KEY SETTINGS SCREEN

RM

The IP Remote Microphone's key-related settings are performed on this screen. The set contents are reflected on the LCD screen of the device.

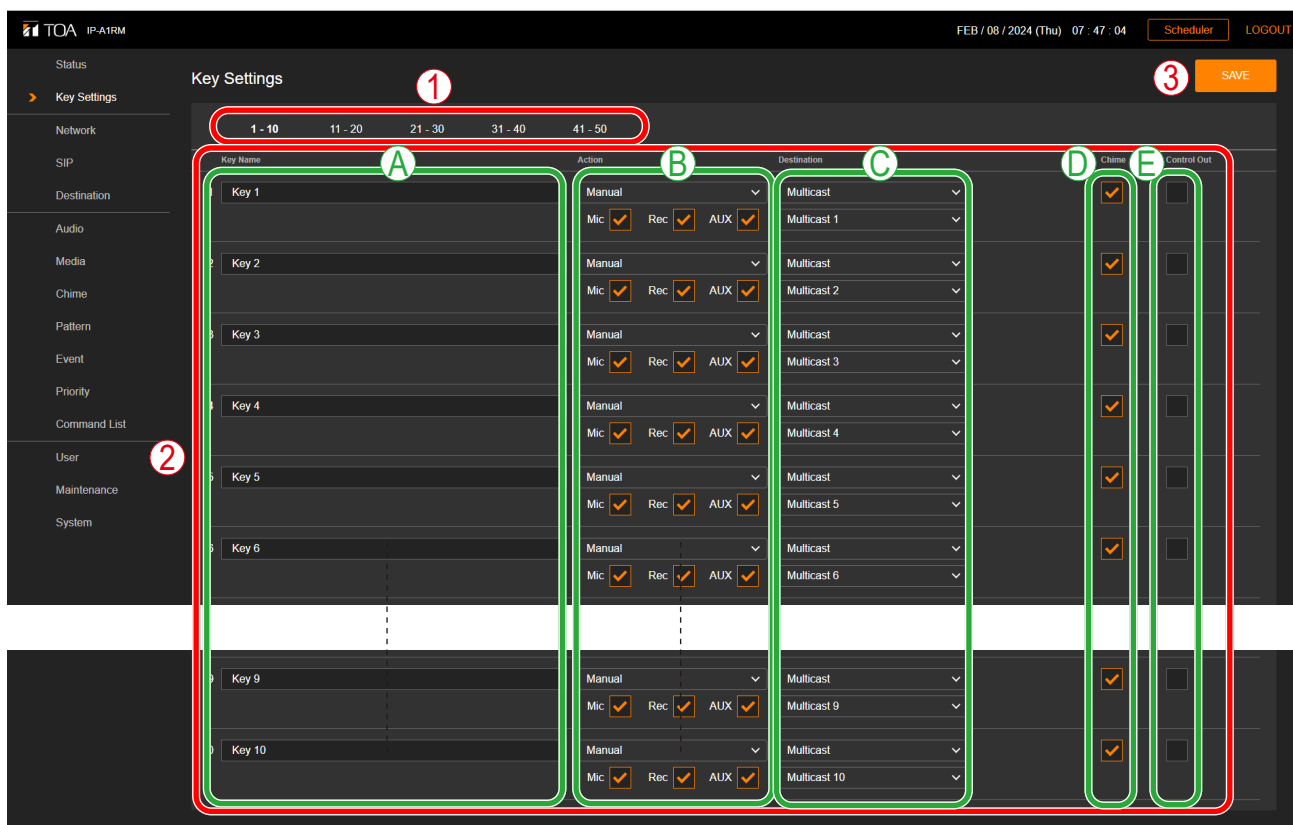

(1) Page Tab

Clicking a tab changes the display to the corresponding key setting screen.

Each tab allows functions to be assigned to 10 keys, for a total of 50 different possible actions.

(2) Key Settings

Set actions to be assigned to each key.

| | Item | Contents |
|---|----------|--|
| A | Key Name | <p>Set the name of the selection key. The set name will be displayed on the IP Remote Microphone's key name display. Up to 32 characters can be displayed.</p> <p>Initial setting: Keys 1 – 50</p> <p>Tip</p> <p>Characters appear on the IP Remote Microphone as follows, depending on the number of characters:</p> <ul style="list-style-type: none"> 1 – 12 characters: 16-point font, 1 line 13 – 16 characters: 12-point font, 1 line 17 – 32 characters: 12-point font, 2 lines |

| | Item | Contents |
|---|-------------|--|
| B | Action | <p>Select the action to be executed when each key is pressed. Items that can be set for each selected action vary. Initial setting: Manual</p> <p>[When "Manual" is selected] Select the audio source to be used for the Manual Broadcast. If multiple audio sources will be used, select each manually during the broadcast by marking the corresponding checkbox on the IP Remote Microphone. Mic: Broadcasts IP Remote Microphone audio. Rec: Broadcasts pre-recorded IP Remote Microphone audio, AUX: Broadcasts AUX input audio.</p> <p>[When "Pattern" is selected] Enable Pattern Broadcast using the internal sound source. The pattern name set on the Pattern setting screen is displayed. Setting range: Patterns 1 – 20</p> <p>[When "Control Out" is selected] Turns the control output ON or OFF.</p> <p>[When "Command Set" is selected] Execute the preset Command Set. The Command Set name is displayed. Setting range: Command Sets 0 – 9</p> |
| C | Destination | <p>When Manual Broadcast or Pattern Broadcast is set, select its broadcast destination.</p> <p>[For Group Broadcasts] Select Multicast as the broadcast destination, then select the channel that will be the final broadcast destination. Setting range: Multicast 1 – 20</p> <p>[For Individual Broadcasts] Select the SIP target for the broadcast destination, then enter the SIP user ID or SIP device IP address as the broadcast destination. When performing Group Broadcast via the IP Paging Gateway, enter the DTMF number set as the broadcast destination.</p> <p>[For Group Broadcast via the IP Paging Gateway] Select the SIP Target as the broadcast destination, then enter the SIP user ID or IP address of the IP Paging Gateway that will become the broadcast destination. When the selected broadcast destination is set to DTMF on the IP Paging Gateway's Conversion Settings screen (p. 45), enter the DTMF number that will correspond to the multicast transmission destination. The DTMF number does not need to be entered if the Transfer Destination is set to Fixed.</p> <p>Initial setting: Multicast # (# differs depending on key.)</p> |
| D | Chime | <p>When Manual Broadcast is selected, first enable or disable the chime. Note that the chime setting can be changed during manual broadcasts from the IP Remote Microphone. Check the checkbox to sound the chime. Initial setting: Checked</p> |

| | Item | Contents |
|---|-------------|---|
| E | Control Out | <p>When Manual Broadcast is selected, external devices can be controlled during a broadcast by control output signals. Check the checkbox to turn the external control output ON when the broadcast is initiated by the set key. Control output is turned OFF when the broadcast is terminated.</p> <p>Initial setting: Keys 1 – 20 checked Keys 21 – 50 unchecked</p> <p>Tip When Pattern Broadcast is selected as an action, set the Control Output linked to the broadcast on the Pattern Setting screen, and display the settings on the Key Setting screen.</p> |

(3) SAVE button

Click to save the settings and changes. (See [p. 31.](#))

9. NETWORK SETTINGS SCREEN

The device's network-related settings are performed on this screen.

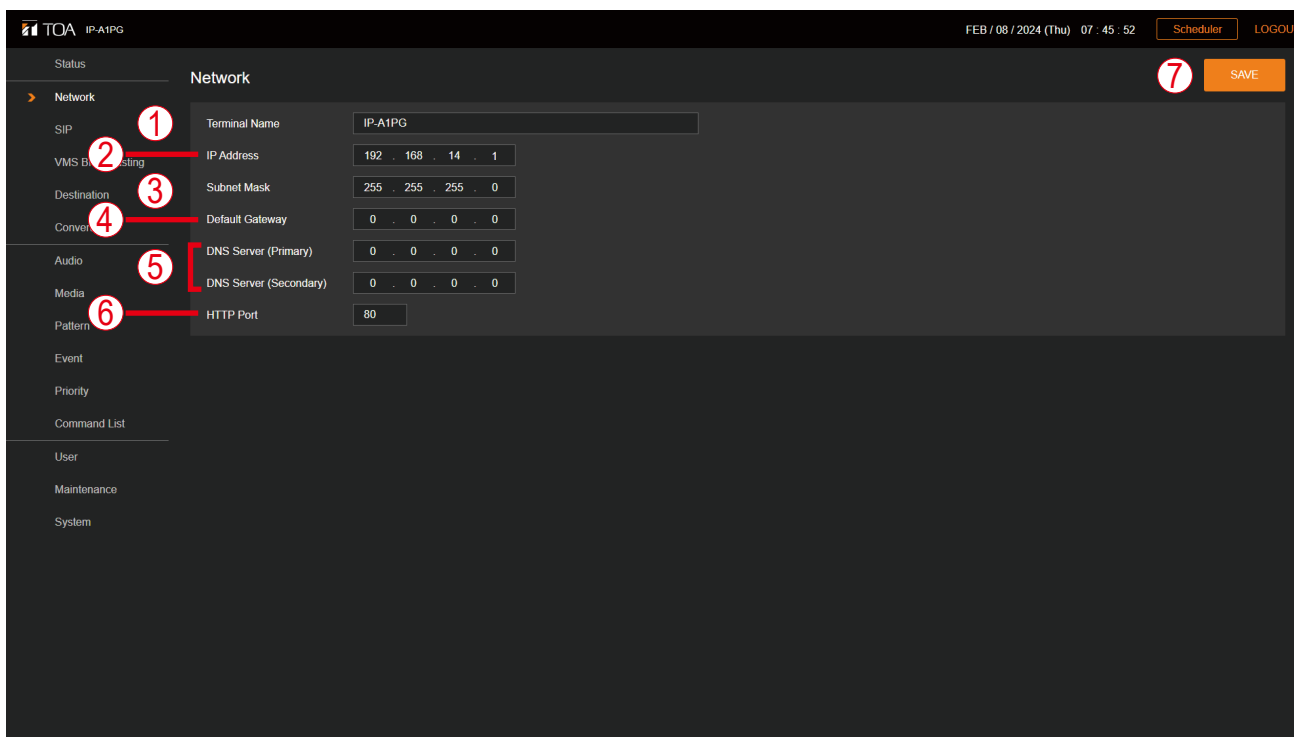

| | Item | Contents |
|-----|---|---|
| (1) | Terminal Name* ¹ ,* ² | Set the device's terminal name. Initial setting: (Product Number) |
| (2) | IP Address* ² | Set the device's IP address. Only private addresses can be entered. Initial setting: 192.168.14.1 |
| (3) | Subnet Mask* ² | Set the device's subnet mask. Initial setting: 255.255.255.0 |
| (4) | Default Gateway* ² | Set the device's default gateway. Initial setting: 0.0.0.0 |
| (5) | DNS Server | Set the primary and secondary DNS server addresses. Initial setting: 0.0.0.0 (Invalid) |
| (6) | HTTP Port | Set the HTTP server support numbers. Normally, this port is used as found in the initial settings. Setting Range: 80 or 10000 – 40000 Initial setting: 80 |
| (7) | SAVE button | Click to save the settings and changes. (See p. 31.) |

*1 For more information on the characters or number of characters that can be set, please refer to "[USABLE CHARACTERS](#)" on [p. 90.](#)

*2 This item's original setting value is retained when the setting file is uploaded.

10. SIP SETTINGS SCREEN

Perform all settings related to SIP connections.

PG

The screenshot shows the SIP configuration interface for device IP-A1PG. The interface is dark-themed and includes a sidebar with navigation options: Status, Network, SIP, VMS Broadcasting, Destination, Convert, Audio, Media, Pattern, Event, Priority, Command, User, Maintenance, and System. The main content area is titled 'SIP' and contains two sections: 'SIP Account Settings' and 'Other Settings'. A 'SAVE' button is located in the top right corner. Red circles with numbers 1 through 14 highlight specific elements: 1. SIP Account Active toggle; 2. SIP Server Address field; 3. SIP Server Port field (5060); 4. Registration Expiry field (1800 sec); 5. User ID field; 6. Display Name field (IP-A1PG); 7. Password field; 8. Authentication ID field; 9. Audio Codec section; 10. Opus codec selected in the 'Enable' dropdown; 11. Call Time Limit field (3600 sec); 12. RTP Timeout field (30 sec); 13. Priority SIP Client checkbox; 14. SAVE button.

RM

The screenshot shows the SIP configuration interface for device IP-A1RM. The interface is dark-themed and includes a sidebar with navigation options: Status, Key Settings, Network, SIP, Destination, Audio, Media, Chime, Pattern, Event, Priority, Command, User, Maintenance, and System. The main content area is titled 'SIP' and contains two sections: 'SIP Account Settings' and 'Other Settings'. A 'SAVE' button is located in the top right corner. Red circles with numbers 1 through 12 highlight specific elements: 1. SIP Account Active toggle; 2. SIP Server Address field; 3. SIP Server Port field (5060); 4. Registration Expiry field (1800 sec); 5. User ID field; 6. Display Name field (IP-A1RM); 7. Password field; 8. Authentication ID field; 9. Audio Codec section; 10. Opus codec selected in the 'Enable' dropdown; 11. Ring Time Limit field (25 sec); 12. Call Time Limit field (3600 sec).

| | Item | Contents |
|------|----------------------------------|---|
| (1) | SIP Account Active | Click on the button to enable or disable the SIP account. ON: The SIP account is enabled and registered with the SIP server. OFF: The SIP account is disabled and will not be registered with the SIP server. The registration status with the SIP server is displayed at right. Registered: Registration successful. Registration Failed: Registration failed. Registering: Registration in progress. Unregistered: Registration invalid. |
| (2) | SIP Server Address* | Set the address of the SIP server. The address can be an IP address or a domain name. Initial setting: Blank |
| (3) | SIP Server Port | Set the remote SIP server port number. Setting range: 1024 – 65532 Initial setting: 5060 |
| (4) | Registration Expiry | Set the device's SIP server registration expiry period. Set an appropriate value according to the registration authentication expiry preset for the SIP server (unit: sec). Setting range: 60 – 7200 Initial setting: 1800 |
| (5) | User ID* | Set the device's SIP account user ID needed when registering the device on the SIP server. Often, this user ID is used when calling up the receiving device. Initial setting: Blank |
| (6) | Display Name* | Set the names of the SIP phone or other SIP devices. The name may be identical to the User ID. Initial setting: Product number |
| (7) | Password* | Set the SIP account password needed to register the device on the SIP server. Initial setting: Blank |
| (8) | Authentication ID* | Enter the authentication ID needed when registering the device on a SIP server. Place a checkmark in the checkbox when using. Initial settings: Checkbox: Blank Authentication ID: Blank |
| (9) | Audio Codec | Move the codecs to be used in SIP broadcasts to the Enable frame at right, and unused codecs to the Disable frame at left. Select the desired codec name button (Opus, G722, G711u or G711a) and click on the [←] or [→] button to move the name to the desired frame. When multiple codecs are selected in the Enable frame, the priority of each codec can be set by clicking on the [∨] or [∧] buttons to change their order. (Higher codecs have priority over lower codecs.) |
| (10) | Ring Time Limit RM | Set the Max. duration for SIP-connected ringing tones. (Unit: sec.) Setting range: 25 – 60 Initial setting: 25 |
| (11) | Call Time Limit | Set the Max. duration for SIP-connected conversations. (Unit: sec) Setting range: 1 – 18000 Initial setting: 3600 |
| (12) | RTP Timeout | When the device receives no RTP packet during a preset duration, the connection times out and is cut off. Setting Range: 5 – 3600 sec. Initial setting: 30 sec. |
| (13) | Priority SIP Client PG | When a SIP call is received from a device that has been set as a priority broadcast source, the SIP call will supersede any other in-progress SIP calls. Place a checkmark in the checkbox when using. Initial settings: Checkbox: Blank Priority SIP Client: Blank |
| (14) | SAVE button | Click to save the settings and changes. (See p. 31.) |

* For more information on the characters or number of characters that can be set, please refer to "USABLE CHARACTERS" on p. 90.

11. VMS BROADCASTING SETTINGS SCREEN

Perform all settings related to VMS connections.

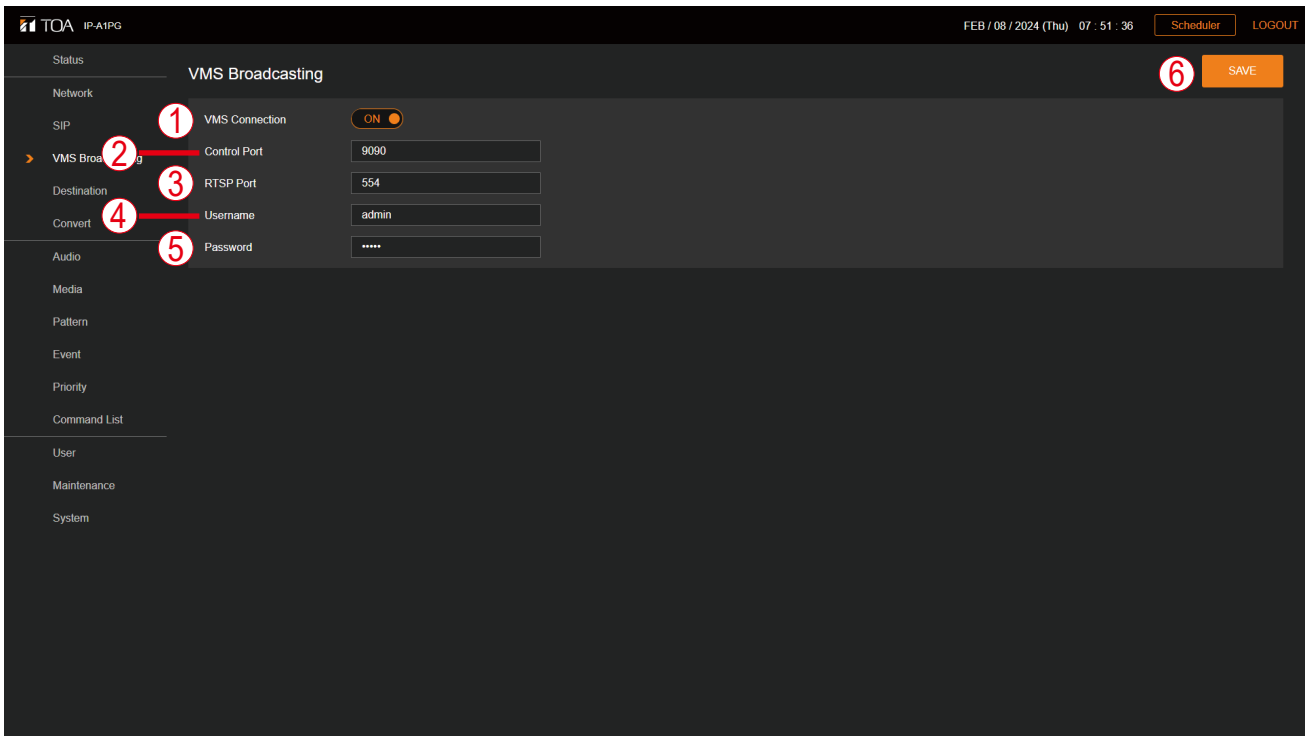

| | Item | Contents |
|-----|----------------|--|
| (1) | VMS Connection | Click on the switch to select whether or not to use the VMS broadcast function. ON: The Onvif server is enabled, allowing VMS broadcasting. OFF: The Onvif server is disabled, rendering VMS broadcasting inoperable. Initial setting: ON |
| (2) | Control Port | Set the control port of the device to which VMS software connects. Setting range: 9090 or 10000 – 40000 Initial setting: 9090 |
| (3) | RTSP Port | Set the RTSP port for streaming video from this device to VMS client. Tip If you want to set the port forwarding on the router, set the same port number on the LAN side and WAN side. Setting range: 554 or 10000 – 40000 Initial setting: 554 |
| (4) | Username* | Enter the device's VMS username, which will be needed for other equipment to make a VMS connection to the device. Initial setting: admin |
| (5) | Password* | Set the password needed for other equipment to make a VMS connection to the device. Default: guest |
| (6) | SAVE button | Click to save the settings and changes. (See p. 31.) |

* For more information on the characters or number of characters that can be set, please refer to "USABLE CHARACTERS" on p. 90.

Note

When performing VMS broadcasting from VMS software in a WAN environment, the VMS software must support RTP/RTSP/TCP (Video/Audio/Audio Backchannel). Please check the manual of the VMS software.

12. DESTINATION SETTING SCREEN

Set the multicast transmission channel to be used as the broadcast destination.

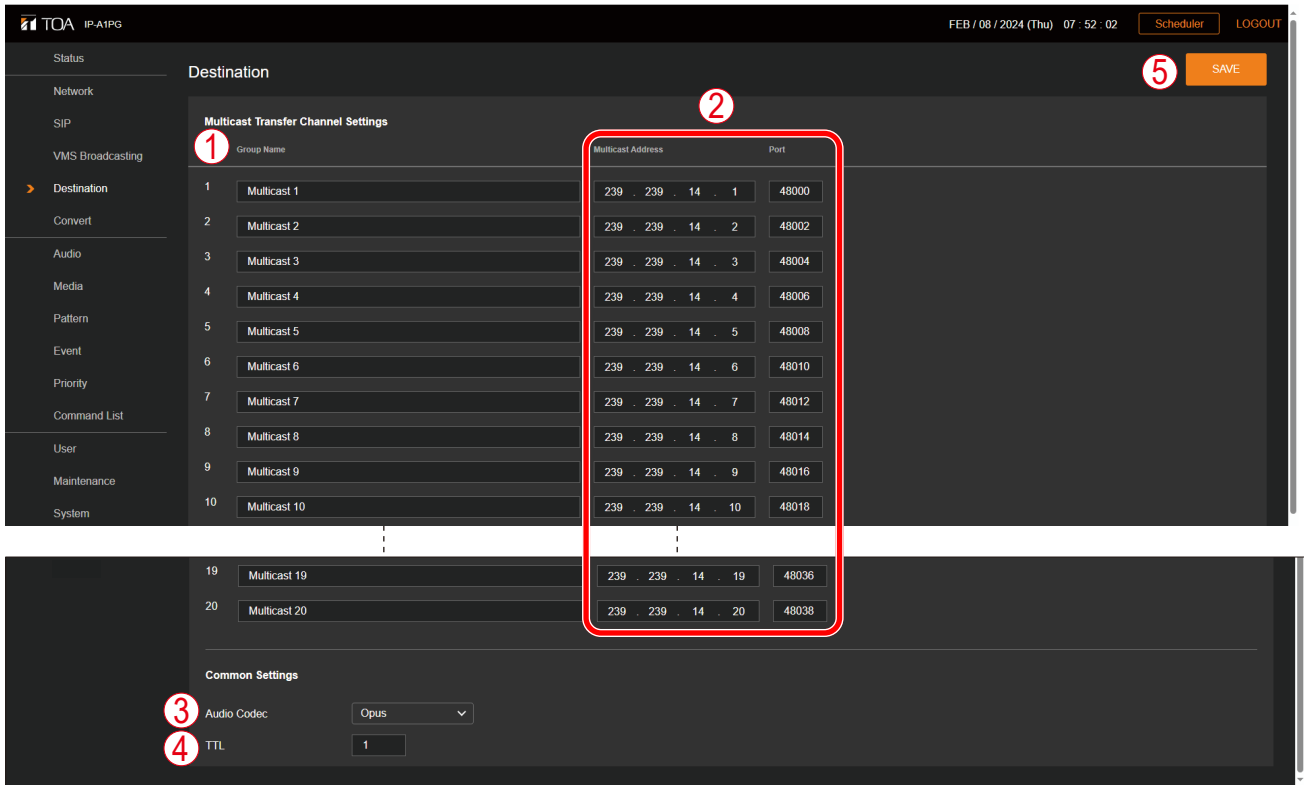

Multicast Transmission Channel Settings

| | Item | Contents |
|-----|--------------------------|--|
| (1) | Group Name* ¹ | The name of the multicast transmission channel can be set. By matching this name with the names of the receiving devices, it can also be used as the name of the broadcast group. Initial setting: Multicast 1 – 20 |
| (2) | Multicast Address/Port | Set the transmission address and port number for multicast audio transmissions. Enter a Class D address for the multicast address, and an even number for the port number. <Multicast Address> Setting range: Class D address Initial setting: 239.239.14.1 – 239.239.14.20 <Port Number> Setting range: 1024 – 65532 Initial setting: 48000 – 48038 (even numbers only) |

*¹ For more information on the characters or number of characters that can be set, please refer to "USABLE CHARACTERS" on p. 90.

Common Settings

| | Item | Contents |
|-----|-------------|---|
| (3) | Audio Codec | Set the codec of the multicast audio to be transmitted. Opus: Audio codec is Opus. G711u: Audio codec is PCMU (G.711u). G711a: Audio codec is PCMA (G.711a). G722: Audio codec is G.722. Initial setting: Opus* ² |
| (4) | TTL | Set the TTL value of the multicast audio to be transmitted. Set an appropriate value for the required multicast routing environment. Setting range: 1 – 255 Initial setting: 1 |
| (5) | SAVE button | Click to save the settings and changes. (See p. 31.) |

*² G.722 if firmware is Ver. 3.0.1 or earlier

13. CONVERSION SETTINGS SCREEN

Set the transfer relationship between the DTMF number and the broadcast destination when SIP broadcasts are received, and the transfer relationship between the audio channel and the broadcast destination when the Transmitting Device is connected to the VMS software.

13.1. SIP Broadcasting Conversion Setting

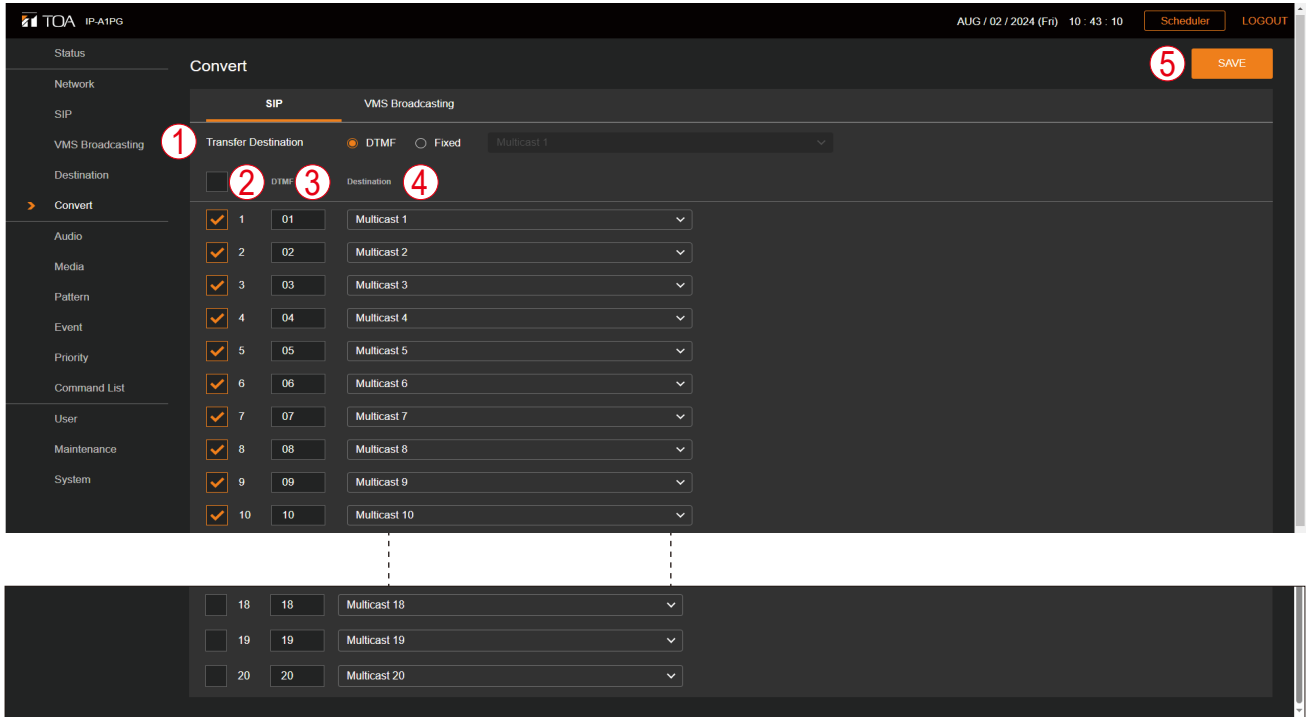

[When DTMF is selected in the Transfer Destination]

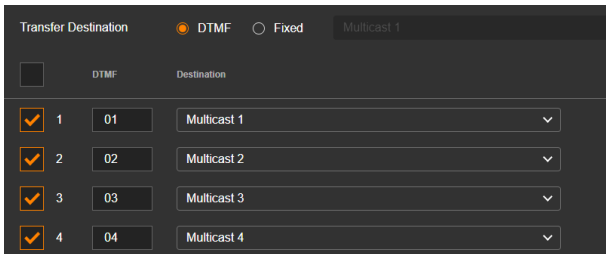

[When Fixed is selected in the Transfer Destination]

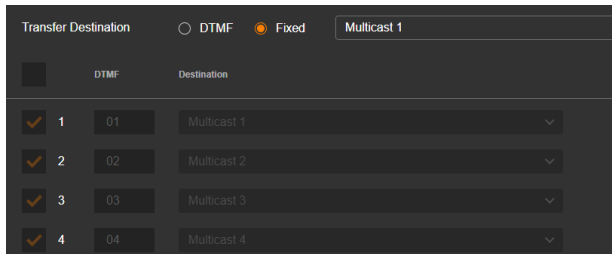

| Item | Contents |
|--------------------------|--|
| (1) Transfer Destination | <p>Sets the method for selecting the broadcast destination to which audio from the SIP phone or IP Remote Microphone will be converted. Setting Range: DTMF, Fixed Initial setting: DTMF</p> <p>[When DTMF is selected] After receiving a SIP call, the unit waits for the DTMF number to be entered. When the DTMF number is recognized, it starts multicast conversion to the broadcast destinations assigned in DTMF (3).</p> <p>[When Fixed is selected] The unit begins multicast conversion to the designated broadcast destination immediately after a SIP call is received. Setting range: Multicast 1 – 20</p> |
| (2) Enable | <p>Check-mark the numbers to be validated as conversion settings. Initial setting: 1 – 10 (checked) and 11 – 20 (unchecked)</p> |

| | Item | Contents |
|-----|-------------|---|
| (3) | DTMF | <p>Set the DTMF number to be used to designate the multicast channel that will become the broadcast destination.</p> <p>The DTMF setting is a 2-digit number. The same DTMF number cannot be assigned to two different conversion settings.</p> <p>Setting range: 0 – 9, *, #, A, B, C, D</p> <p>Initial setting: 01 – 20</p> <p>Note</p> <p>The transmitting device's signaling system is compatible with the following protocols, but is not compatible with the in-band DTMF:</p> <ul style="list-style-type: none"> • DTMF over RTP (RFC2833) • SIP INFO message |
| (4) | Destination | <p>Select the multicast transmission channel to which the SIP phone audio will be transferred. The Group Name set in the Destination settings is displayed.</p> <p>Setting range: Multicast 1 – 20</p> <p>Initial setting: Multicast 1 – 20</p> |
| (5) | SAVE button | Click to save the settings and changes. (See p. 31.) |

13.2. VMS Broadcast Conversion Settings

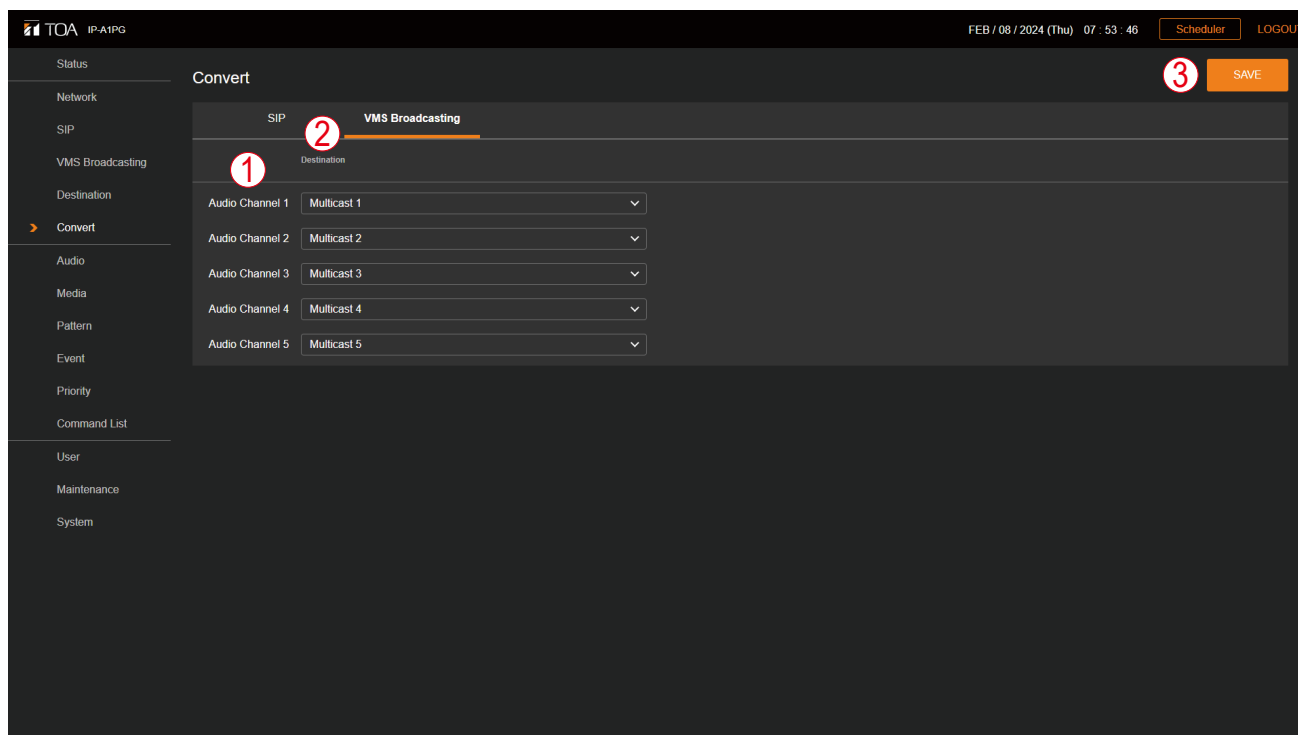

| | Item | Contents |
|-----|---------------------|---|
| (1) | Audio Channel 1 – 5 | When the Transmitting Device is connected to the VMS software via ONVIF, it is recognized as having 5 audio channels. Set the transfer relationships for each of the 5 channels and their broadcast destination (multicast transmission channel). |
| (2) | Destination | Select the multicast transmission channel to which the VMS audio will be transferred. The Group Name set in the Destination settings is displayed. Setting range: Multicast 1 – 20 Initial setting: Multicast 1 – 5 |
| (3) | SAVE button | Click to save the settings and changes. (See p. 31.) |

13.3. When Converting from SIP to Multicast Broadcasting

This section explains the method used to select the broadcast Destination when performing multicast broadcast by calling the IP Paging Gateway from a SIP phone or the IP Remote Microphone.

13.3.1. Regarding Destination Selection for Broadcasts Initiated by SIP phone

[When DTMF is selected in the Transfer Destination]

Step 1. Use the SIP phone to call the IP Paging Gateway.

Make a call from the SIP phone using the IP Paging Gateway's SIP user ID or IP address. If the IP Paging Gateway automatically receives the call, it is placed in the DTMF number input standby mode, and continuous sounds like those described below are heard:

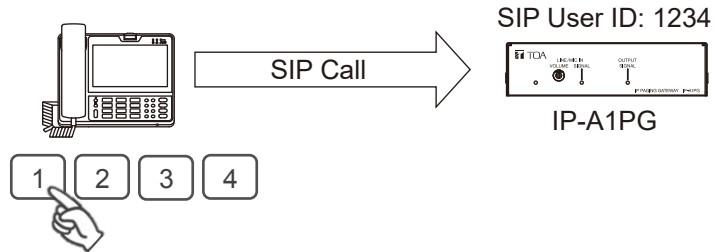

"Tirorin, tirorin, tirorin, tirorin"

The DTMF number input standby mode continues for 30 seconds, and the above sound is heard for the duration of the standby mode interval.

Step 2. Enter the DTMF number assigned to the broadcast destination.

While in DTMF number input standby mode (30 seconds), enter the DTMF number assigned to the desired Destination, which was set on the Conversion settings screen. If a valid DTMF number is entered, a sound like the one described below is heard, allowing the broadcast to be initiated.

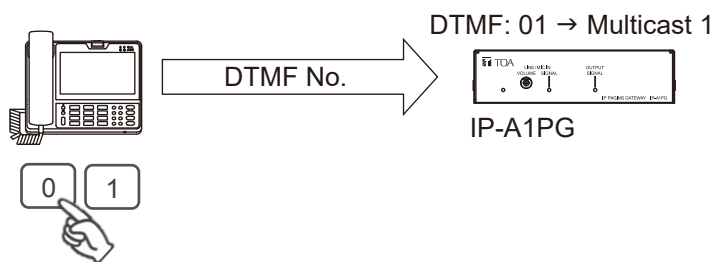

"Popopinponpan"

If the duration of the DTMF number input standby mode exceeds 30 seconds, or the wrong DTMF number is entered, a sound like the one described below is heard, followed by the automatic termination of communications.

"Popon – popon"

Note

The transmitting device's DTMF signal system is compatible with the following protocols. However, it is not compatible with the in-band DTMF. Some SIP phones allow the DTMF signal system to be changed.

- DTMF over RTP (RFC2833)
- SIP INFO message

Step 3. Initiate the broadcast.

Voice input from the handset is broadcast to the selected broadcast destinations.

Step 4. Terminate the SIP phone broadcast.

Replacing the handset to finish the call terminates the broadcast.

[When Fixed is selected in the Transfer Destination]

Step 1. Use the SIP phone to call the IP Paging Gateway.
Make a call from the SIP phone using the IP Paging Gateway's SIP user ID or IP address.

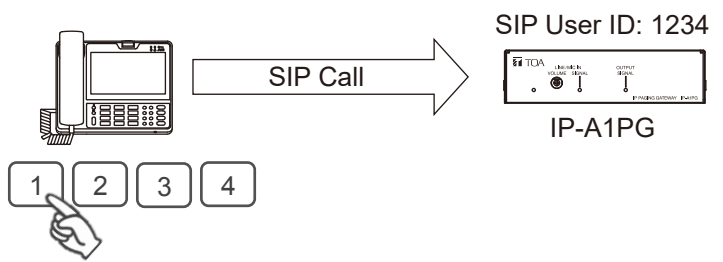

Step 3. Initiate the broadcast.
When the IP Paging Gateway automatically receives a call, audio from the receiver is broadcast to the selected broadcast destinations.

Step 4. Terminate the SIP phone broadcast.

13.3.2. Broadcast destination selection using the IP Remote Microphone

[When DTMF is selected in the Transfer Destination]

Be sure that the IP Remote Microphone's Selection keys are preset in advance. The broadcast destination is set by assigning a SIP user ID or IP address to the IP Paging Gateway, as well as the DTMF number set as the broadcast destination at the IP Paging Gateway.

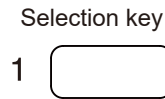

Assignment example
User ID: 1234
DTMF No.: 01

Step 1. Call the IP Paging Gateway from the IP Remote Microphone.

A SIP connection is made to the IP Paging Gateway, when the IP Remote Microphone's Selection key (preset as the broadcast destination) is pressed, followed by the Broadcast key.

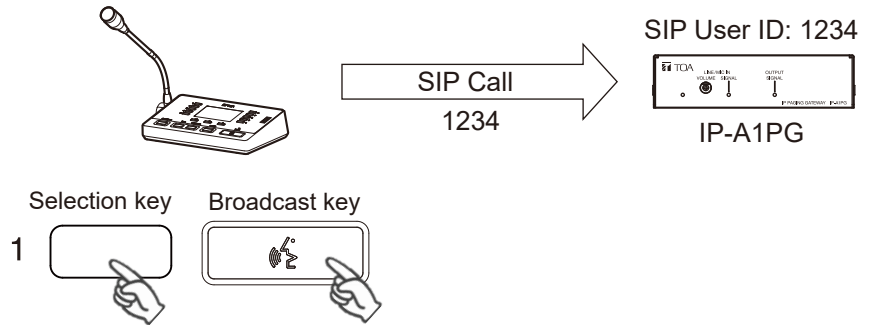

The DTMF number is automatically sent by the IP Remote Microphone to the IP Paging Gateway after establishing a SIP connection.

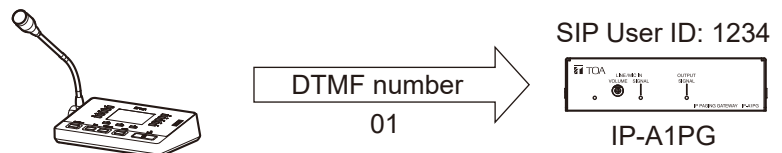

After the DTMF number is accepted, the IP Paging Gateway returns a DTMF response which, when received, causes the Microphone indicator to light up in blue, indicating that the system is ready for broadcasting.

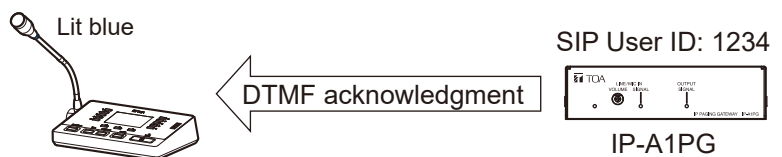

Tip

If there is no DTMF response from the IP Paging Gateway, the IP Remote Microphone will automatically start broadcasting after DTMF-response wait timeout.

Step 2. Begin the broadcast.

Audio from the IP Remote Microphone is broadcast to the selected broadcast destinations.

Step 3. End the broadcast.

Press the IP Remote Microphone's Broadcast key once again to end the broadcast.

[When Fixed is selected in the Transfer Destination]

Be sure that the IP Remote Microphone's Selection keys are preset in advance. The broadcast destination is set by assigning a SIP user ID or IP address to the IP Paging Gateway.

Selection key

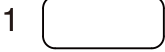

Assignment example
User ID: 1234

Step 1. Call the IP Paging Gateway from the IP Remote Microphone.

A SIP connection is made to the IP Paging Gateway, when the IP Remote Microphone's Selection key (preset as the broadcast destination) is pressed, followed by the Broadcast key.

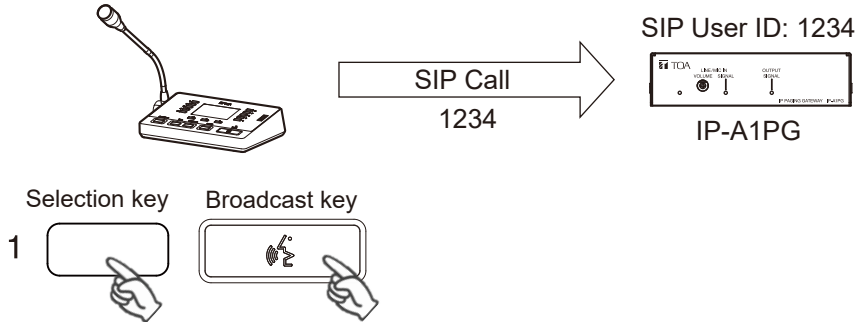

The Microphone indicator lights up in blue, indicating that the system is ready for broadcasting after establishing a SIP connection.

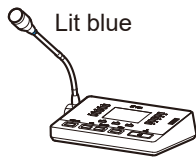

Step 2. Begin the broadcast.

Audio from the IP Remote Microphone is broadcast to the selected broadcast destinations.

Step 3. End the broadcast.

Press the IP Remote Microphone's Broadcast key once again to end the broadcast.

14. AUDIO SETTINGS SCREEN

PG

Perform settings regarding an audio to be transmitted from the LINE/MIC input to the network.

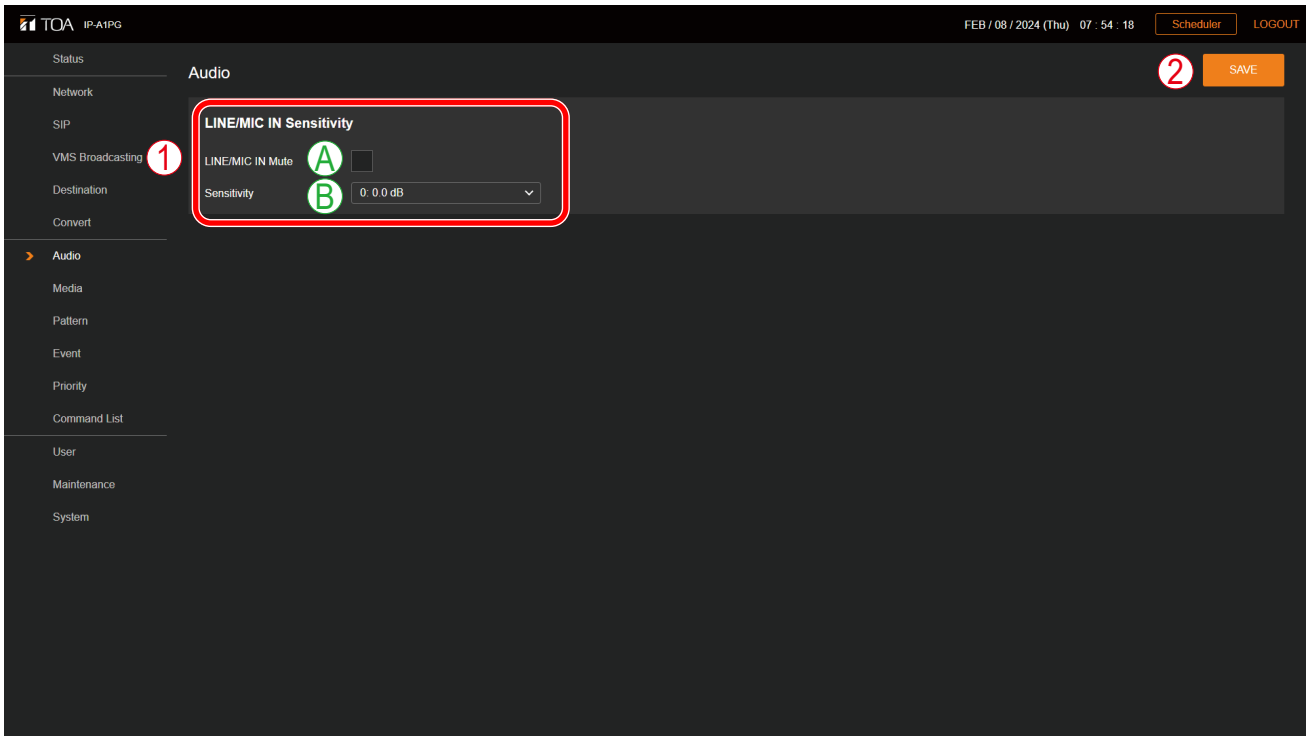

(1) LINE/MIC IN Sensitivity

| | Item | Contents |
|---|------------------|--|
| A | LINE/MIC IN Mute | Checking the box mutes the audio from the LINE/MIC input. The LINE/MIC input mute is reflected immediately after the SAVE button is clicked. Initial setting: Unchecked (unmute) |
| B | Sensitivity | Set the sensitivity of the LINE/MIC input. Changes in the sensitivity setting are reflected immediately after the SAVE button is clicked. Setting range: 0 (0.0 dB) – 8 (+12.0 dB) Initial setting: 0 (0.0 dB) |

(2) SAVE button

Click to save the settings and changes. (See [p. 31.](#))

Perform settings regarding an audio to be transmitted from the IP-A1RM to the network.

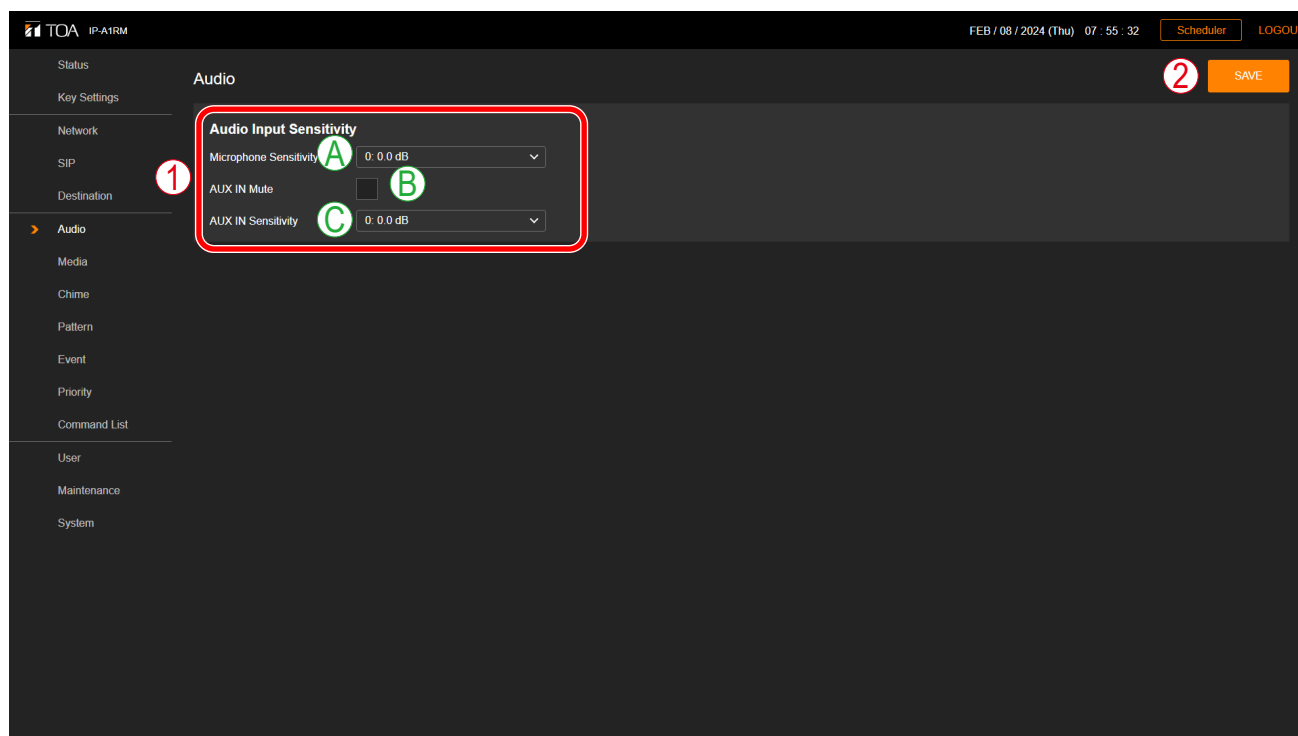

(1) Audio Input Sensitivity

| | Item | Contents |
|---|------------------------|--|
| A | Microphone Sensitivity | Set the sensitivity of the Microphone input. Changes in the sensitivity setting are reflected immediately after the SAVE button is clicked. Setting range: 0 (0.0 dB) – 8 (+12.0 dB) Initial setting: 0 (0.0 dB) |
| B | AUX IN Mute | Checking the box mutes the audio from the AUX input. The AUX input mute is reflected immediately after the SAVE button is clicked. Initial setting: Unchecked (unmute) |
| C | AUX IN Sensitivity | Set the sensitivity of the AUX input. Changes in the sensitivity setting are reflected immediately after the SAVE button is clicked. Setting range: 0 (0.0 dB) – 8 (+12.0 dB) Initial setting: 0 (0.0 dB) |

(2) SAVE button

Click to save the settings and changes. (See [p. 31.](#))

14.1. Conceptual Diagram of the Sound Volume Settings Function

Please refer to the following diagram for information regarding which volume settings are enabled for each broadcast sound source:

PG

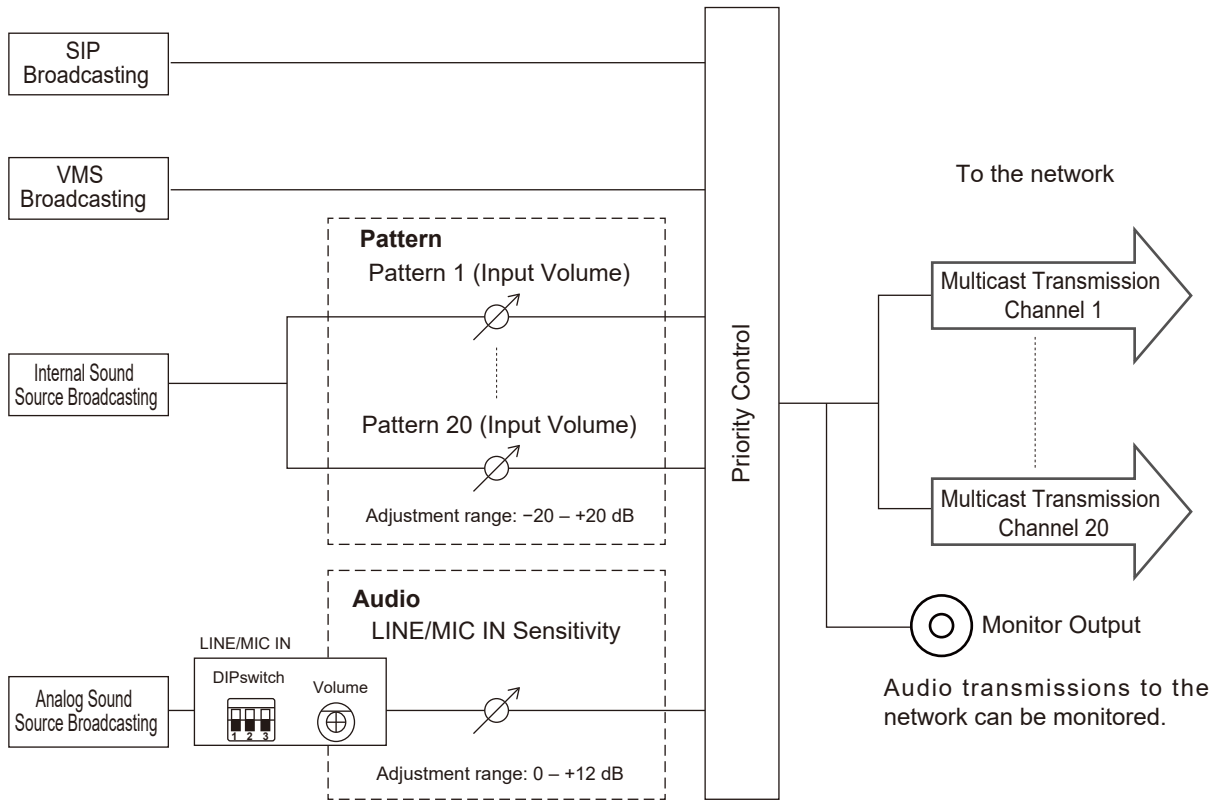

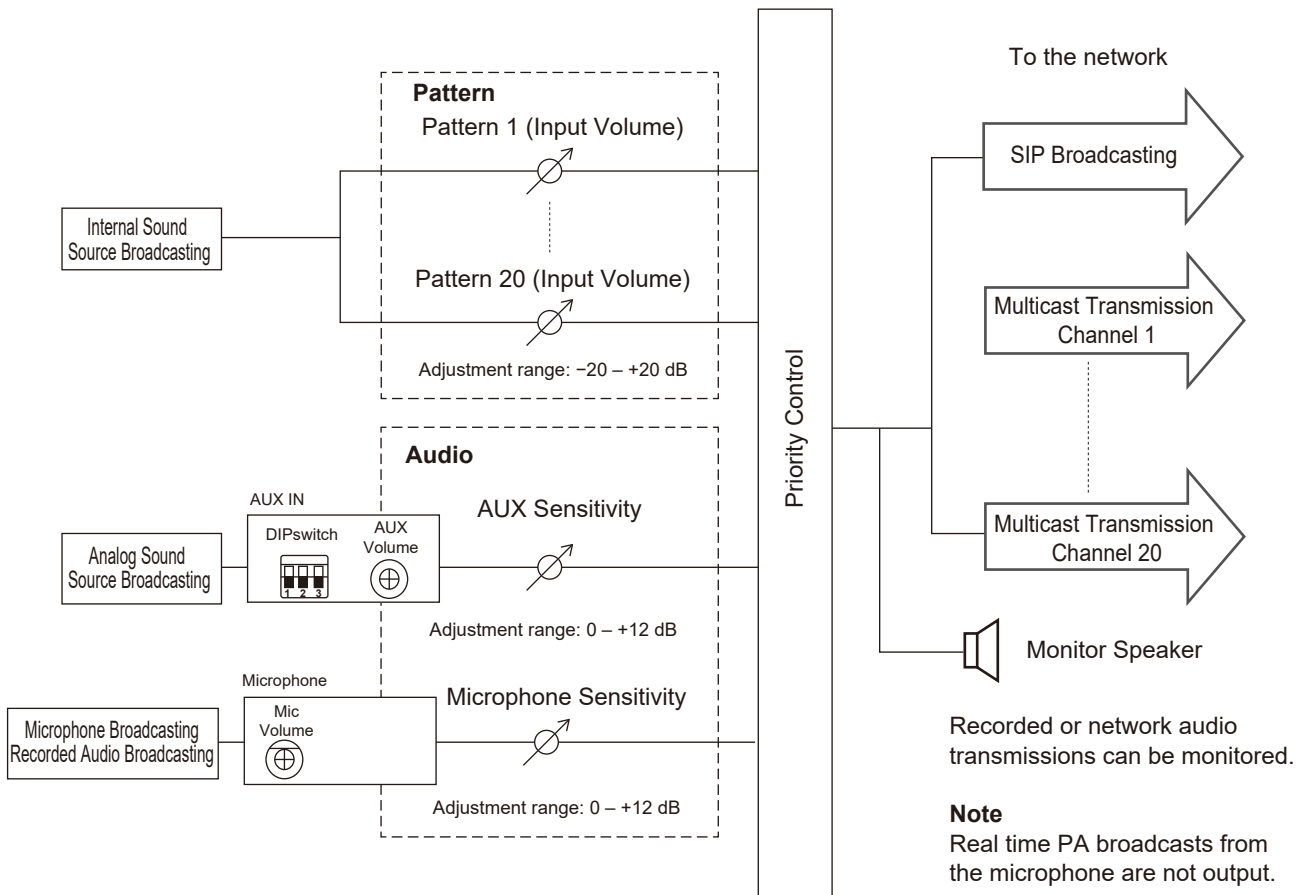

[The trick to successful audio volume settings]

- Take care not to increase the sound source's volume level too much at input. (If the sound source is distorted at this point, distortion cannot be eliminated by subsequent audio settings.)
- In order to balance the sound volume of the internal sound sources of all connected receiving devices, adjust each individual Input Volume setting.
- To change the sound volume of the receiving devices, adjust the master volume control of each receiving device.
- In order to set different sound volumes for the same sound source, so that it can be used in two types of broadcast (i.e. normal volume and emergency volume), set the transmitting device to use two different multicast channels, which will then be received as different sound sources by the receiving devices, thus effectively realizing two volume settings for the same sound source.

15. MEDIA SETTING SCREEN

This screen is used to upload, download or delete the internal sound source files.

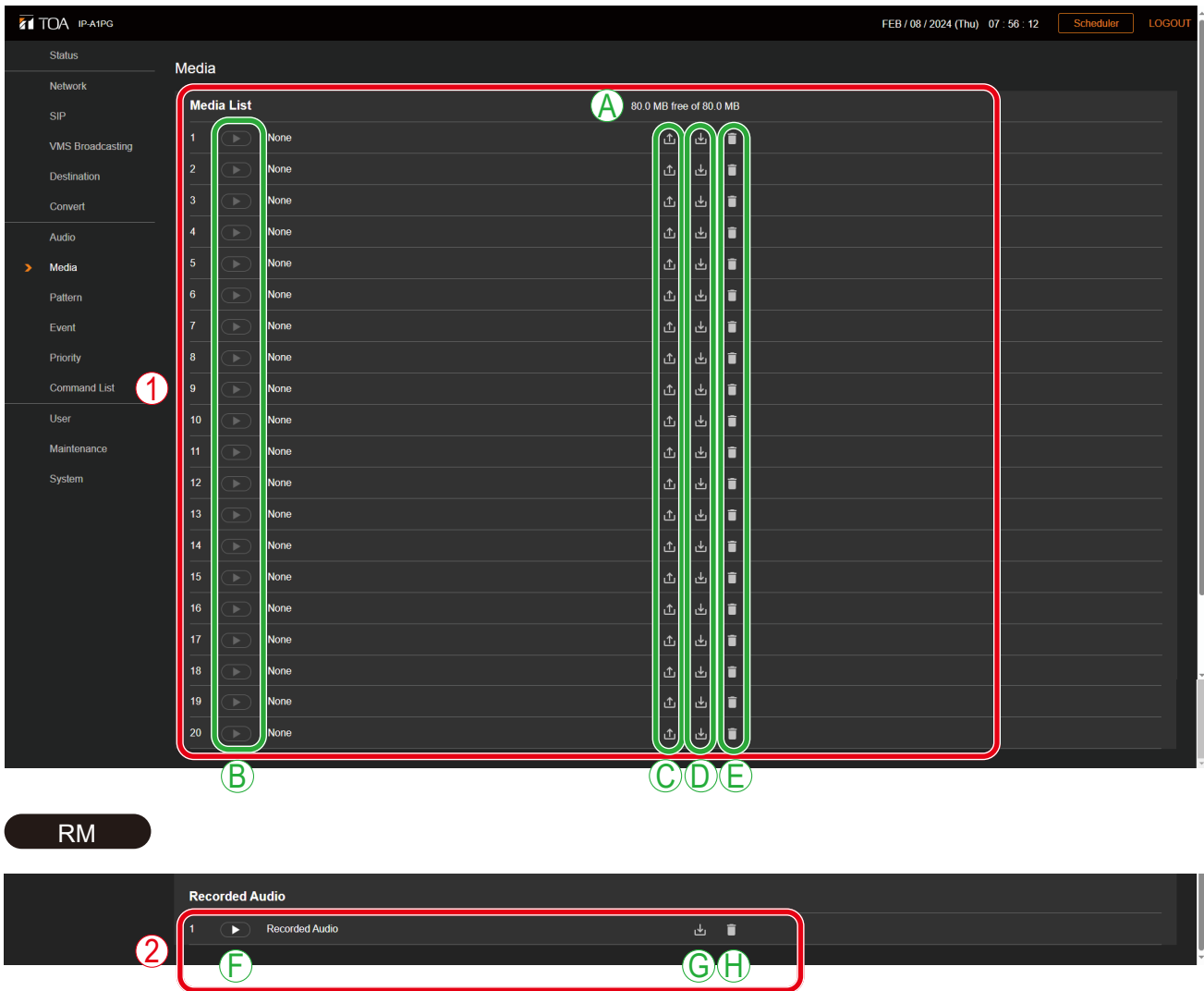

(1) Internal Sound Source List (Media List)

This list shows the names of the sound source files currently stored in the device. Sound source files can be registered to media numbers 1 – 20. Either MP3 or WAV files can be uploaded to the device.

| | Item | Contents |
|---|--|---|
| A | Available capacity for internal sound source files | Displays max. device capacity (80 MB) and currently available sound source file upload capacity. |
| B | Sound Source File Playback Button | All sound source files currently registered on the Internal Sound Source list can be played back by way of a PC, and confirmed as audio. If no sound files are registered, the playback button will not be enabled. |
| C | Upload Icon | Uploads PC-saved sound source files to the device and adds them to the Internal Sound Source list. (See "Uploading Sound Source Files" on p. 58.) |
| D | Download Icon | Downloads sound source files from the device and saves them to the PC. (See "Downloading Sound Source Files" on p. 58.) |
| E | Delete Icon | Deletes sound source files from the device. (See "Deleting Sound Source Files" on p. 59.) |

(2) Recorded audio **RM**

This refers to a sound source file recorded from the IP Remote Microphone's built-in microphone. This file can be downloaded, deleted, or played back on a PC.

| | Item | Contents |
|---|-------------------------------------|---|
| F | Recorded Audio File Playback Button | A sound source file recorded from the IP Remote Microphone's built-in microphone can be played back by way of a PC, and confirmed as audio. |
| G | Download Icon | Downloads a sound source file from the device and saves it to the PC. (See "Downloading Sound Source Files" on p. 58.) |
| H | Delete Icon | Deletes a sound source file from the device. (See "Deleting Sound Source Files" on p. 59.) |

15.1. Uploading Sound Source Files

Follow the procedure below to upload sound source files to the device:

Max. sound source file storage capacity is 30 MB per file and 80 MB total.

Supported file formats are as follows:

WAV file: 8/16/44.1/48 kHz sampling frequency, 8/16 bit, monaural/stereo

MP3 file: 32/44.1/48 kHz sampling frequency, 64 to 320 kbps, CBR/VBR, monaural/stereo

Notes

- There are restrictions on the types of characters that can be used for filenames. Files that do not meet these conditions cannot be uploaded. Upload the file after changing the filename to one that consists of only usable characters, referring to "[USABLE CHARACTERS](#)" on p. 90.
- When an internal sound source broadcast is in progress, uploading the sound source file to the same media numbers selected for the in-progress broadcast will cause the broadcast to stop.

Tip

Sound source file format and file size are roughly indicated as follows:

| Sound source file format | File size per minute | Approximate sound source length for 30MB file. | Total saveable time (for 80 MB) |
|----------------------------------|----------------------|--|---------------------------------|
| WAV (monaural, 48 kHz, 16 bit) | 5.8 MB | About 5 minutes | About 14 minutes |
| WAV (monaural, 44.1 kHz, 16 bit) | 5.3 MB | About 5 minutes | About 15 minutes |
| WAV (monaural, 44.1 kHz, 8 bit) | 2.6 MB | About 11 minutes | About 30 minutes |
| MP3 (monaural, 320 kbps) | 2.4 MB | About 12 minutes | About 33 minutes |
| MP3 (monaural, 256 kbps) | 1.9 MB | About 16 minutes | About 42 minutes |
| MP3 (monaural, 192 kbps) | 1.4 MB | About 21 minutes | About 56 minutes |
| MP3 (monaural, 128 kbps) | 1.0 MB | About 32 minutes | About 83 minutes |

Note that the above times are only provided as a guide. Total times may be shorter than those indicated, depending on the recording device or the data creation method.

Step 1. Click on the Upload icon  to the right of the media number to be saved.
The file explorer opens.

Step 2. Select the sound source file to be uploaded to the device.

Step 3. Click on the OK button.
Upload begins.

Following upload completion, the new sound source filename is added to the displayed Internal Sound Source list.

15.2. Downloading Sound Source Files

Follow the procedure below to download internal sound source files or a recorded audio file:

Step 1. Click on the Download icon  to the right of the media number to be saved to the PC.
The file explorer opens.

Step 2. Select the folder where the file will be saved.

Step 3. Click on the OK button.
The selected sound source file is downloaded.

15.3. Deleting Sound Source Files

Follow the procedure below to delete internal sound source files or a recorded audio file:

Note

When the sound source file being used for an internal sound source broadcasting is deleted, the broadcast will stop.

Step 1. Click on the Delete icon  to the right of the media number to be deleted. The dialog box is displayed.

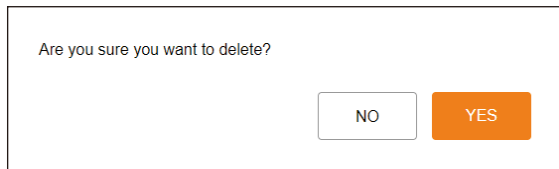

Step 2. Click on the YES button. The selected sound source file is deleted.

16. CHIME SETTINGS SCREEN

Perform settings for the Manual Broadcast chimes.

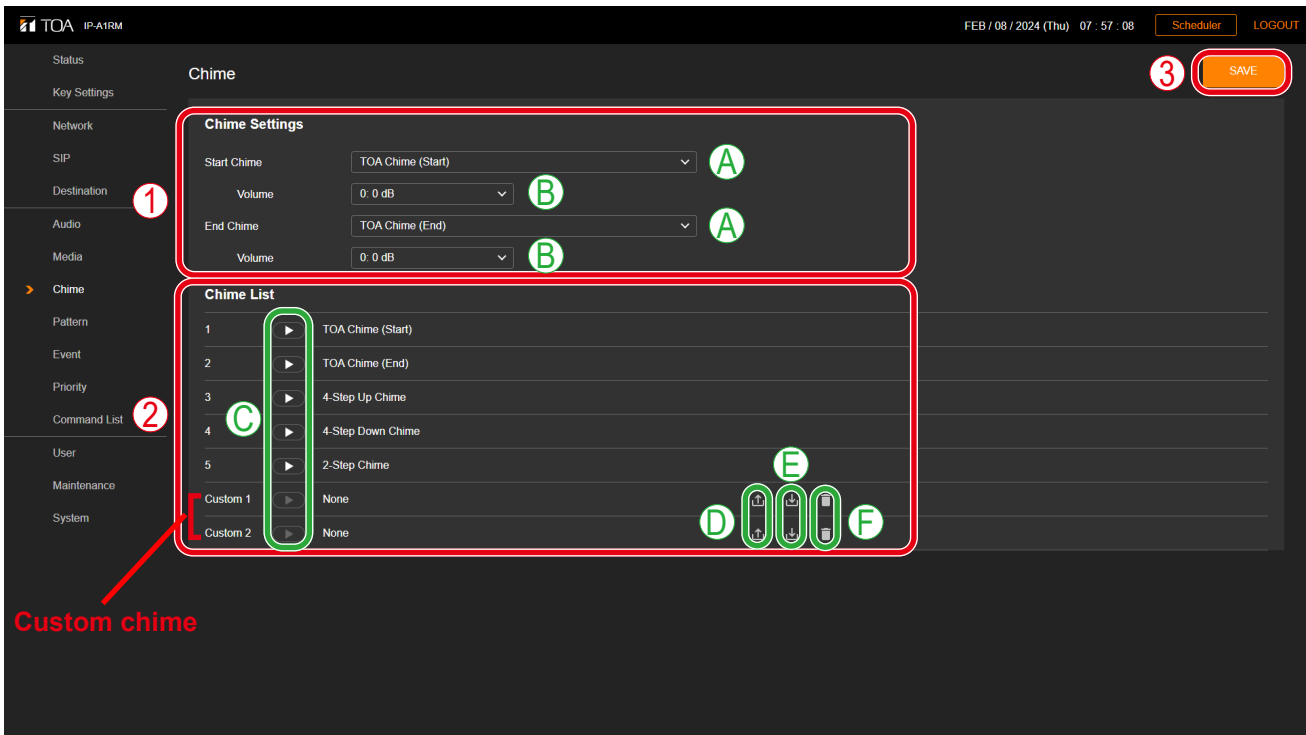

(1) Chime Settings

Select the type of chime to sound when starting or stopping a Manual Broadcast, and its output volume.

| | Item | Contents |
|---|------------------------|--|
| A | Start Chime, End Chime | From the pulldown menu, select the type of the chime to sound before and after Manual Broadcasts. Initial setting: Start Chime: TOA Chime (Start) End Chime: TOA Chime (End) |
| B | Volume | Set the output volume of the Start and End chimes. Setting range: -20 dB - +20 dB Initial setting: 0 (0.0 dB) |

(2) Chime List

The pre-registered IP Remote Microphone Chime files are displayed in Items 1 – 5.

Custom chimes are displayed in Items 6 and 7. Any audio source file can be uploaded to the IP Remote Microphone and used as a chime.

| | Item | Contents |
|---|-----------------|--|
| C | Playback Button | All sound source files currently registered on the Internal Sound Source list can be played back by way of a PC, and confirmed as audio. |
| D | Upload Icon | Uploads PC-saved sound source files for custom chimes to the device. |
| E | Download Icon | Downloads sound source files for custom chimes from the device and saves them to the PC. |
| F | Delete Icon | Deletes a sound source file for custom chimes from the device. |

Tip

The specifications of the usable sound source files for custom chimes are as follows;

- Max. sound source file size: 1 MB per file
- Supported file formats:
 - WAV file: 8/16/44.1/48 kHz sampling frequency, 8/16 bit, monaural/stereo
 - MP3 file: 32/44.1/48 kHz sampling frequency, 64 to 320 kbps, CBR/VBR, monaural/stereo

(3) SAVE button

Click to save the settings and changes. (See p. 31.)

17. PATTERN REGISTRATION SCREEN

Up to 20 internal sound source files can be registered as a broadcast pattern for broadcast in synchronization with specific events.

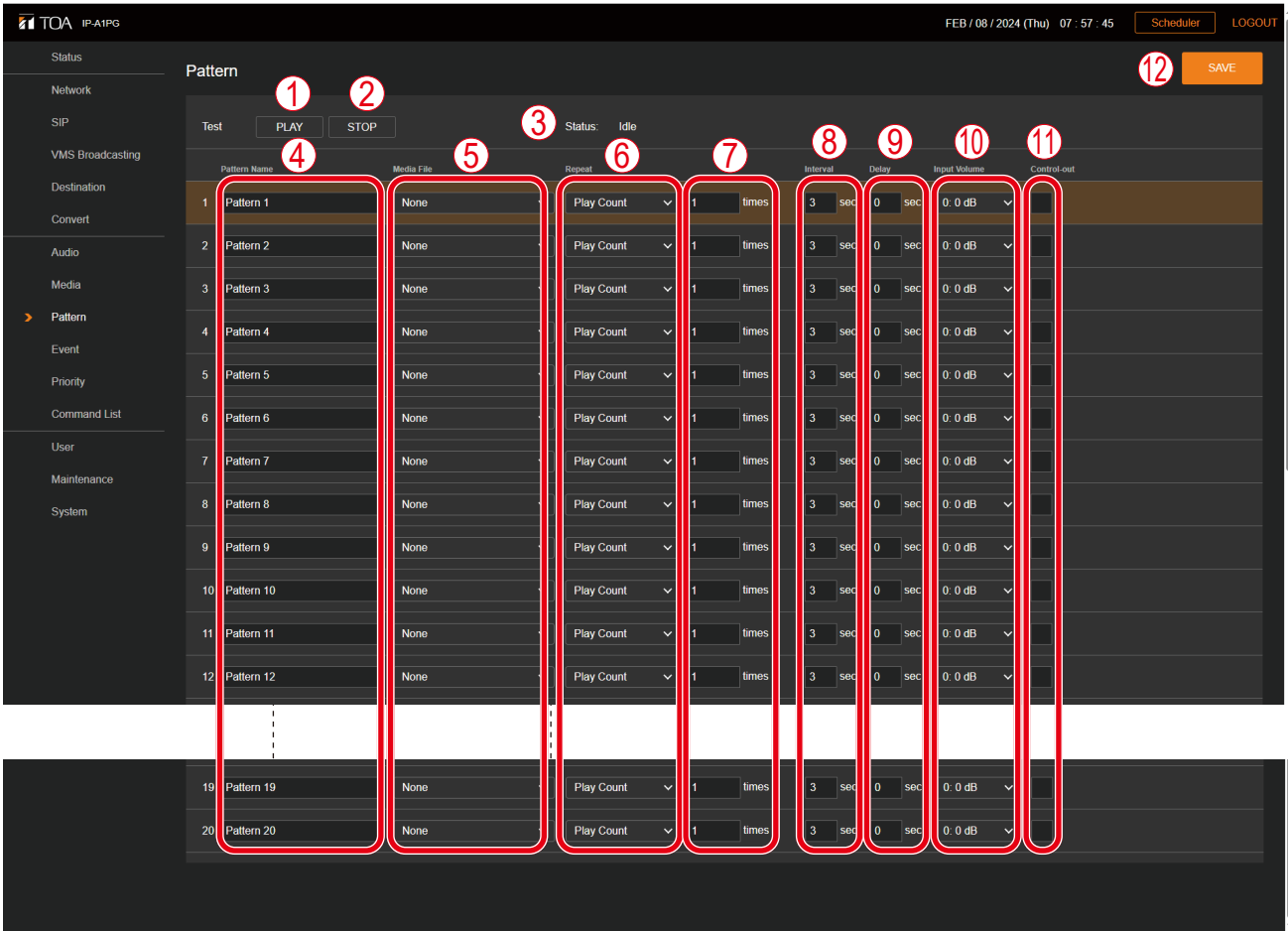

[When Duration is selected in the Repeat setting (6)]

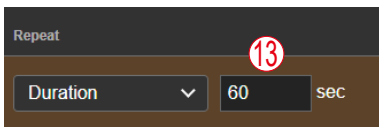

| | Item | Contents |
|-----|--|--|
| (1) | PLAY button | Test broadcasts can be run to check how the set patterns will be broadcast. Click PLAY button, and audio will be output from the monitor output PG or monitor speaker RM . |
| (2) | STOP button | The test broadcast can be stopped by clicking this button. |
| (3) | Status | Displays the device's operating status. Displays the sound source being broadcast when the unit is in broadcast mode. (See " Status Screen and Status Indicators " on p. 36.) |
| (4) | Pattern Name* | Assigns a name to each pattern. Initial setting: Pattern 1 – 20 |
| (5) | Media Files (Internal sound source files) | Select the sound source files to be broadcast in each pattern from internal sound source files or a recorded audio file. Initial setting: None |

* For more information on the characters or number of characters that can be set, please refer to "[USABLE CHARACTERS](#)" on p. 90.

| | Item | Contents |
|------|--|---|
| (6) | Repeat | Select the type of broadcast repetition from among the following two patterns: Play Count: Designate the number of times the broadcast is repeated. Duration: Designate the length of time that the broadcast is repeated. Initial setting: Play Count |
| (7) | Play Count | This function's settings are enabled if Play Count is selected in the Repeat setting (6). Set the number of broadcast repetitions to be executed following input of the Event Trigger. Setting range: 1 – 10 (times) Initial setting: 1 (time) |
| (8) | Interval | Set the sound source's play interval (the interval from the end of play to the start of the next repetition) when performing repeated broadcasting. Setting range: 0 – 99 (sec.) Initial setting: 3 (sec.) |
| (9) | Delay | Set the delay time from the input of the Event Trigger to the start of play. This can be used if the beginning of a broadcast is cut off or in similar situations. Setting range: 0 – 99 (sec.) Initial setting: 0 (sec.) |
| (10) | Input Volume | The input volume can be set to equalize the sound output of individual patterns or change the output level for each pattern. Changes to the input volume settings are enabled from the next broadcast after such changes are saved. Setting range: –20 to +20 dB Initial setting: 0 dB |
| (11) | Control-out (Control output button) | Connected external equipment can be controlled by transmitting a signal from the control output during broadcasts of internal sound source files. If the checkbox at right is marked, the external control output turns ON when the device begins broadcasting internal sound source files, and turns OFF when the broadcast is stopped. Initial setting: Unchecked |
| (12) | SAVE button | Click to save the settings and changes. (See p. 31.) |
| (13) | Duration | This function is enabled if Duration is selected in the Repeat setting (6). Set the length of time the broadcast will be repeated following input of the Event Trigger. Setting range: 5 – 3600 (sec.) Initial setting: 60 (sec.) |

The broadcast repetition method can be selected from between the following two variations: Play Count, or the number of times that a broadcast is repeated, the total Duration of the broadcast.

Each of these functions can be enabled as follows, depending on the combination with other setting items:

[If Play Count is selected]

Designate the number of times the sound source playback will be repeated. The following operation is performed when Edge is selected as the Signal Mode and the start trigger is a control input, or if the receiving device is externally controlled by remote API.

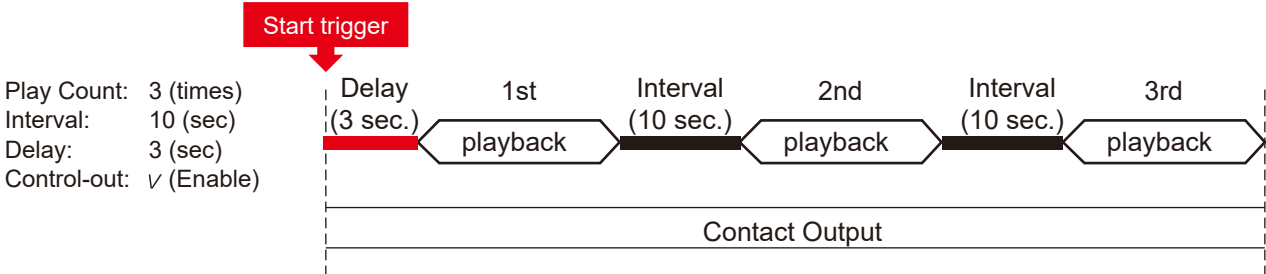

[If broadcast duration is selected]

Designate the duration of repeated play. The following operation is performed when Edge is selected as the Signal Mode and the start trigger is a control input, or if the receiving device is externally controlled by remote API.

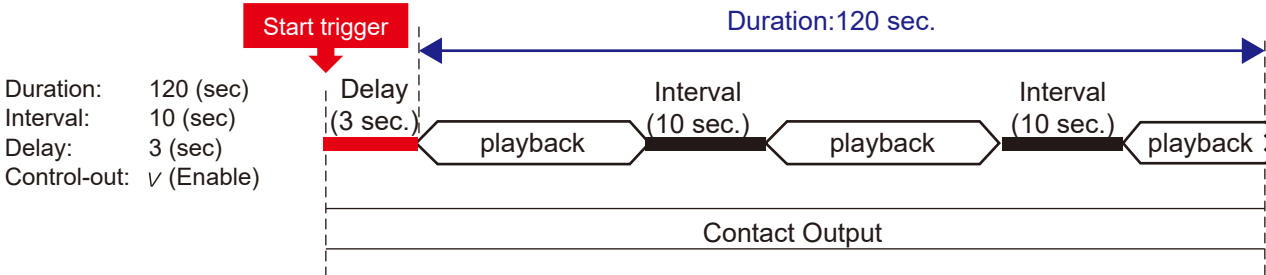

[Controlling Start-to-Finish Duration When the Control Input Signal Mode is Set to Level]

Broadcasts are repeatedly played back with no limit to the number of repetitions when Level is selected as the Signal mode, even if the Repeat pattern setting is set to "Play Count" or "Duration," for the entire period of time between the initial start trigger and the end trigger. The Interval time setting is applied as the duration between different sound sources.

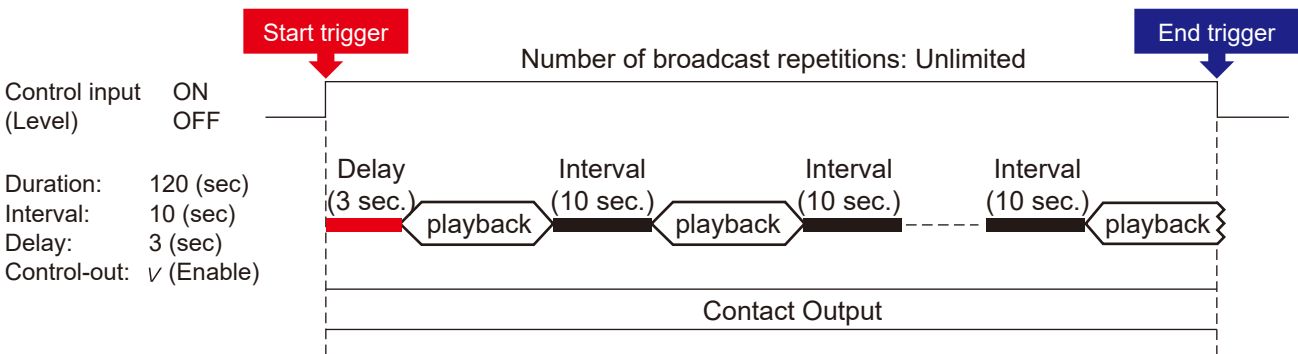

17.1. Performing Tests of Pattern Broadcast

Follow the procedure below to conduct broadcast tests for selected broadcast patterns:

Note

The PLAY button cannot be used if the set contents have not yet been saved.

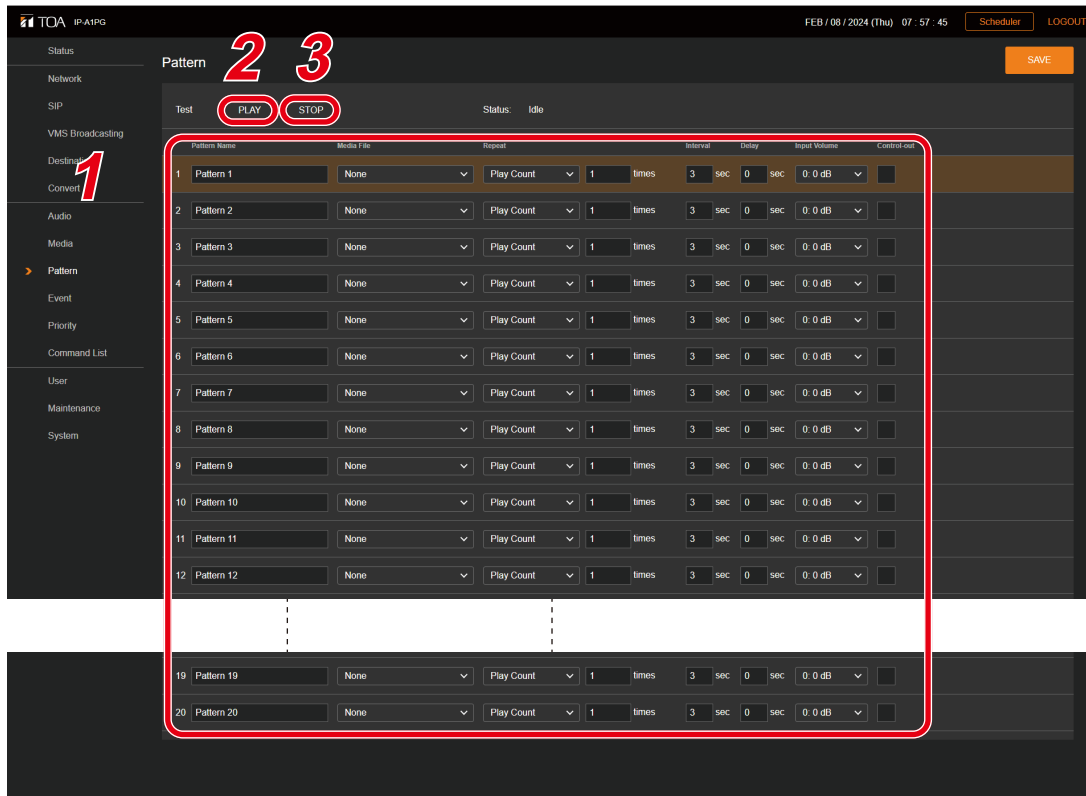

Step 1. Click and select the broadcast pattern to be tested.

Step 2. Click on the PLAY button.

A test broadcast of the selected broadcast pattern will begin.

Tip

Audio is provided from the monitor output **PG** or monitor speaker **RM** , and not as multicast audio to the network.

Step 3. Click on the STOP button to stop the test.

The test broadcast stops.

18. EVENT SETTINGS SCREEN

Perform all settings related to contact control input and output.

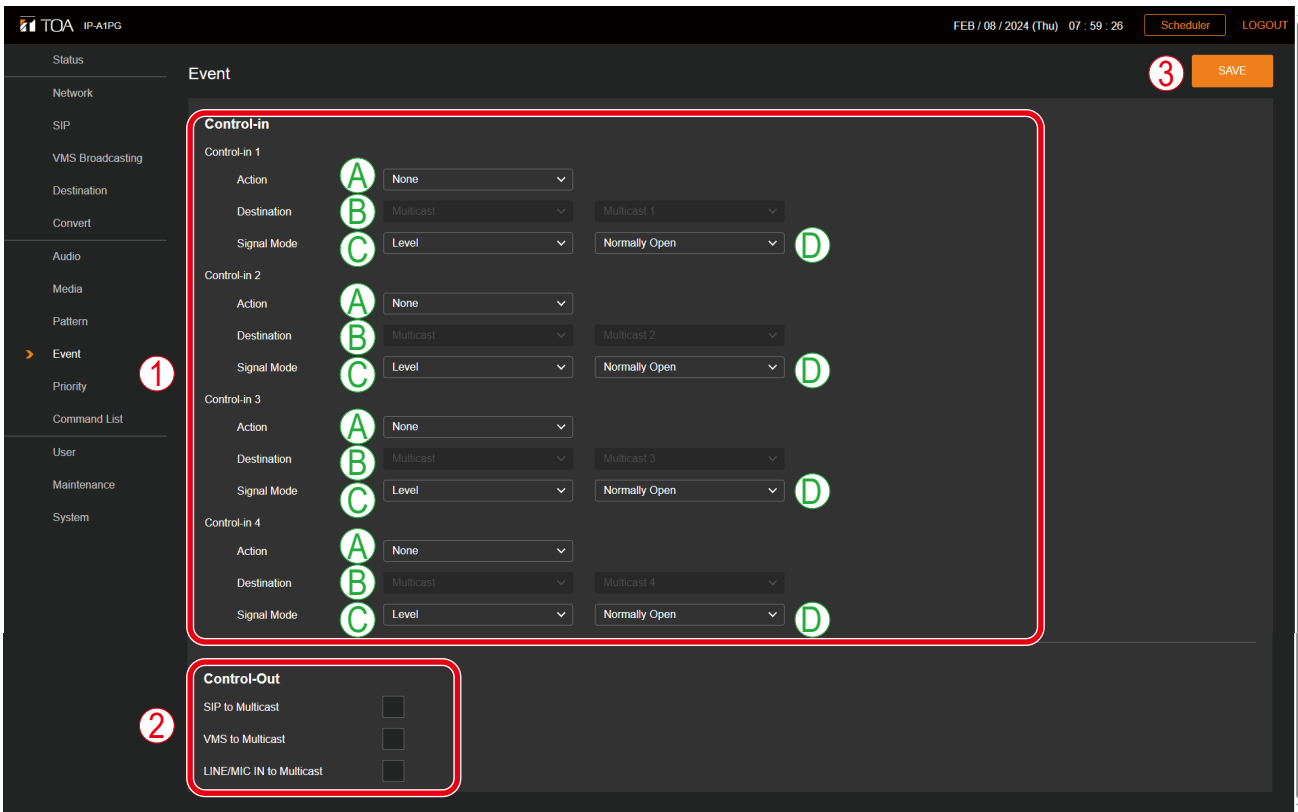

RM

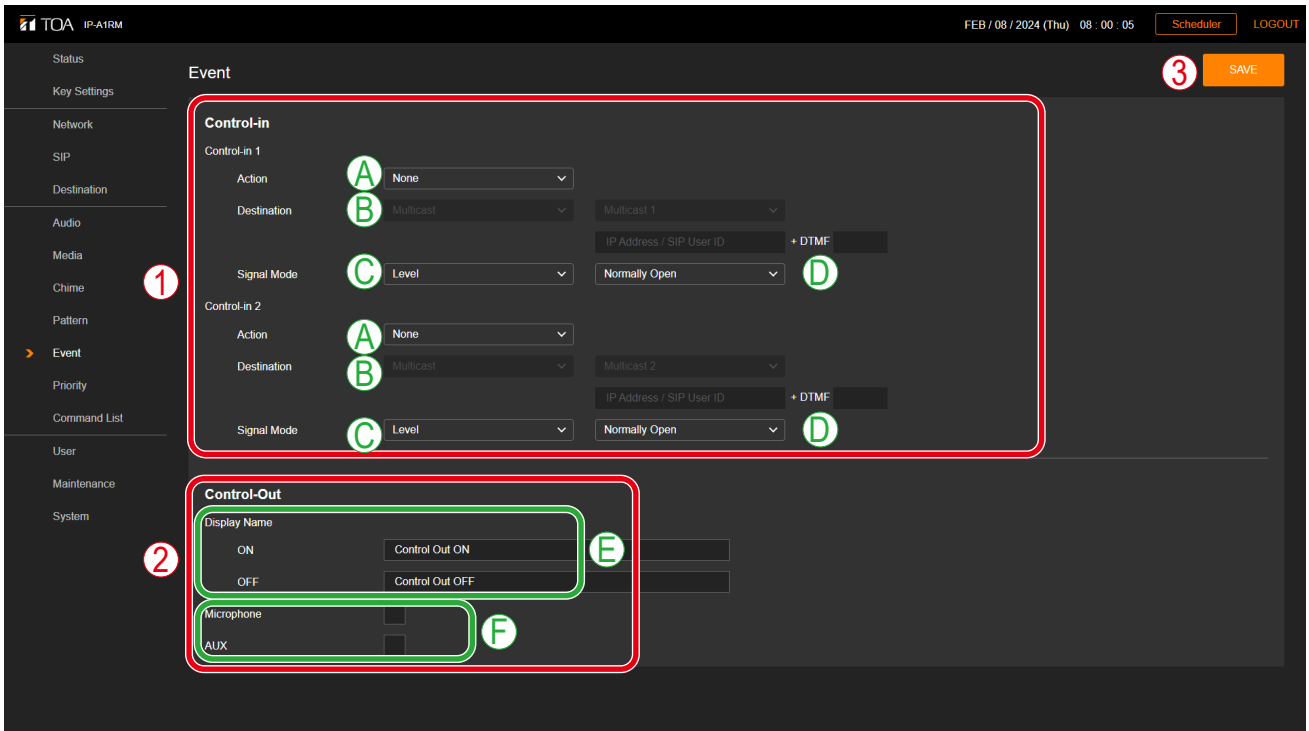

(1) Control-in

Various event actions can be set for each control input, and can be executed by the input of a control signal from connected external equipment.

| | Item | Contents |
|---|-------------------|---|
| A | Action | <p>Select the action to be executed when a control signal is received. Combinations of selectable actions and individual signal modes are shown in the following table. Initial setting: None</p> <p>Tip The same Action cannot be set for multiple control inputs (Control-in 1 – 4). However, this does not apply to LINE/MIC IN PG and AUX RM. The same Action can be set to create events with different broadcast destinations.</p> |
| B | Destination | <p>When a broadcast Action (Patterns 1 – 20, LINE/MIC IN PG or AUX RM) is selected, be sure to select the multicast transmission channel that will function as the broadcast Destination. For Group broadcasts, select Multicast as the broadcast destination, then select the desired multicast transmission destination channels. Setting range: Multicast 1 – 20 Initial setting: Multicast 1 – # (# represents the channel number of the control input.)</p> <p>RM</p> <p>[For Individual broadcasts] Select SIP Target as the broadcast destination, then enter the SIP user ID or IP address of the destination SIP device.</p> <p>[For Group broadcasts using the IP Paging Gateway] Select the SIP Target as the broadcast destination, then enter the SIP user ID or IP address of the IP Paging Gateway that will become the broadcast destination. When the selected broadcast destination is set to DTMF on the IP Paging Gateway's Conversion Settings screen (p. 45), enter the DTMF number that will correspond to the multicast transmission destination. The DTMF number does not need to be entered if the Transfer Destination is set to Fixed.</p> |
| C | Signal Mode | <p>Set the signal mode of the control signal.</p> <p>Level: The designated action is only executed while the control signal is ON. The action is terminated when the control signal is OFF.</p> <p>Edge: Only the start trigger (that switches ON the control signal) is detected.</p> <p>Initial setting: Level</p> |
| D | Control Condition | <p>Set the control signal's control conditions.</p> <p>Normally Open: The circuit is normally disconnected (open), and turns ON when shorted. (Make contact)</p> <p>Normally Closed: The circuit is normally shorted (closed), and turns ON when opened. (Break contact)</p> <p>Initial setting: Normally Open</p> |

Configurable actions are as follows;

Tip

The same Action cannot be set for multiple control inputs (Control-in 1 – 4). However, this does not apply to LINE/MIC IN **PG** and AUX **RM**. The same Action can be set to create events with different broadcast destinations.

| Configurable actions | Contents | Level | Edge |
|--------------------------|--|-------|------|
| None | No action set. | — | — |
| Pattern 1 – 20 | Initiates pattern broadcasting with internal sound source. | ✓* | ✓ |
| LINE/MIC IN PG | Starts and ends LINE/MIC IN input broadcasts. | ✓ | — |
| AUX RM | Starts and ends AUX input broadcasts. | ✓ | — |
| Command Set 0 – 9 | Executes the Command Set to be registered on the Command List screen. | — | ✓ |
| Broadcast Disable | Disables the current broadcast while the control signal input is in progress, and stops transmitting audio broadcasts from the transmitting device, switching the device to Idle mode. | ✓ | — |
| System Mute | Switches the transmitting device to System Mute mode during control signal input, and stops audio broadcasts from the transmitting device. Simultaneously, it mutes all receiving devices in the same network as the multicast audio stream, including any devices that may be broadcasting individually, making it possible to switch the entire system to mute mode. | ✓ | — |

* Broadcasts are repeatedly played back with no limit to the number of repetitions when Level is selected as the Signal mode, even if the Repeat pattern setting is set to "Play Count" or "Duration," for the entire period of time between the initial start trigger and the end trigger. The Interval time setting is applied as the duration between different sound sources.

(2) Control-out

PG

Connected external equipment can be operated by trigger signals transmitted from the control output during device broadcasts.

Set which control output the transmitting device should turn ON during individual broadcasts.

SIP to Multicast: The control output turns ON during SIP audio multicast broadcasts, and turns OFF again when the broadcast is complete.

VMS to Multicast: The control output turns ON during VMS audio multicast broadcasts, and turns OFF again when the broadcast is complete.

LINE/MIC to Multicast: The control output turns ON during the LINE/MIC input multicast broadcasts, and turns OFF again when the broadcast is complete.

Initial setting: Unchecked

Tip

Regarding control output settings when broadcasting internal sound source files, refer to "Control output (10)" in the preceding Pattern Registration screen (p. 61).

Connected external equipment can be operated by trigger signals transmitted from the control output during device broadcasts.

Set which control output the transmitting device should turn ON during individual broadcasts.

| | Item | Contents |
|---|----------------|--|
| E | Display Name | <p>Set the name when the control output of the IP Remote Microphone is ON or OFF.</p> <p>This name is displayed on the Control Output screen whenever the control output is manually operated.</p> <p>ON: Control Out ON</p> <p>OFF: Control Out OFF</p> |
| F | Control Output | <p>During IP Remote Microphone broadcasts, external devices can be operated by control output signals.</p> <p>Set which broadcasts will enable the IP Remote Microphone control output.</p> <p>Microphone: Control output turns ON during IP Remote Microphone broadcasts, and turns OFF again when the broadcast is terminated.</p> <p>AUX: Control output turns ON during broadcasts from the AUX input, and turns OFF again when the broadcast is terminated.</p> <p>Initial Setting: Unchecked</p> |

Tip

Regarding control output settings when broadcasting internal sound source files, refer to "Control output (10)" in the preceding Pattern Registration screen (p. 61).

(3) SAVE button

Click to save the settings and changes. (See p. 31.)

[Broadcasting from the internal sound source (when selecting Patterns 1-20)]

Tip

Pattern Broadcasting, as described below, refers to broadcasts made by playing a pattern list previously set on the Pattern Registration screen. The pattern list can include combinations of selections and repeated play of sound sources, as well as delay, interval, input volume, enabling or disabling of control outputs, etc.

In cases in which the signal mode is set to Edge

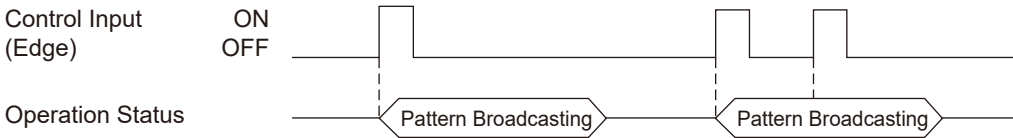

Starts internal sound source broadcast after detecting an Edge signal. The broadcast is not interrupted, even if the same Event Trigger is received.

In cases in which the signal mode is set to Level

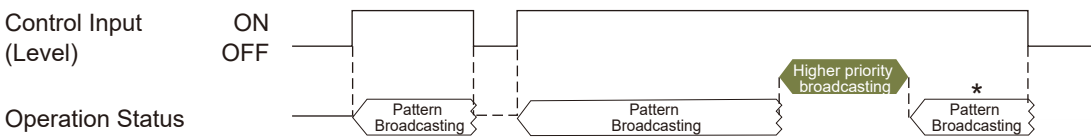

Broadcast continues while the Level signal is received, automatically repeating the broadcast pattern, regardless of the length of the played sound source. If the broadcast is interrupted by a higher priority broadcast, and the Level signal continues to be maintained when the higher priority broadcast ends, the broadcast pattern starts again from the beginning.

Tip

Broadcasts are repeatedly played back with no limit to the number of repetitions when Level is selected as the Signal mode, even if the Repeat pattern setting is set to "Play Count" or "Duration," for the entire period of time between the initial start trigger and the end trigger. The Interval time setting is applied as the duration between different sound sources.

RM

* If SIP Target is selected as the broadcast destination, the broadcast is not resumed after higher priority broadcasts end.

[Broadcasting Analog Sound Sources (When LINE/MIC IN **PG or AUX **RM** is selected)]**

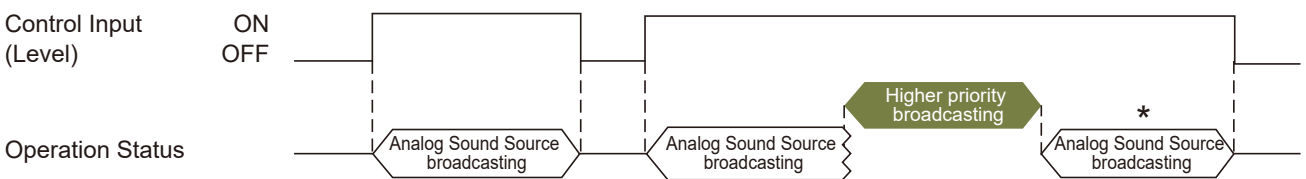

Broadcasting continues during Level signal input. When the broadcast is interrupted by a higher priority broadcast, it will be restored if the Level signal is still present when the higher priority broadcast is complete.

RM

* If SIP Target is selected as the broadcast destination, the broadcast is not resumed after higher priority broadcasts end.

[Stopping the Broadcast (When Broadcast Disable or System Mute is enabled)]

Audio broadcasts from the transmitting device can be stopped by selecting Broadcast Disable or System Mute as the control input event.

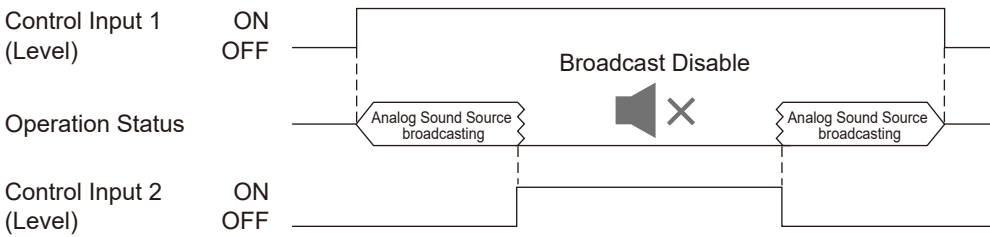

[Broadcast Disable] stops audio broadcasting from the transmitting device during Level signal input, and switches the system to Broadcast Disable mode.

[System Mute] stops audio broadcasting from the transmitting device during Level signal input. Simultaneously, it mutes all network receiving devices receiving the multicast audio stream, including any devices that may be broadcasting individually, making it possible to switch the entire system to mute mode.

19. PRIORITY SETTINGS SCREEN

The priority order of each broadcast function can be set or modified.

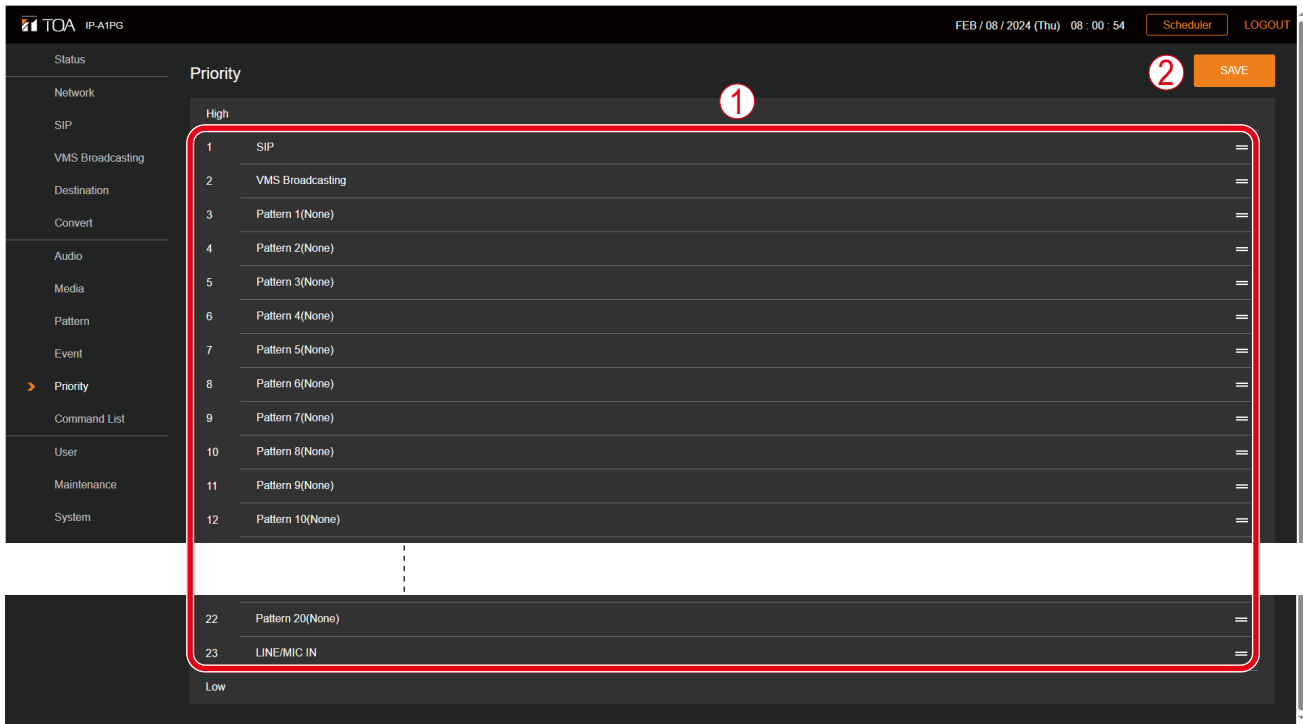

| | Item | Contents |
|-----|--------------------|--|
| (1) | Priority Broadcast | <p>Broadcast priorities can be changed by swapping places in the displayed order. The broadcast priority rises as its displayed position in the list moves upward, while the priority level lowers as the displayed position moves downward. The display order can be changed by drag & drop. For operation, please refer to "About broadcast switching due to broadcast priority settings" on p. 72.</p> <p>PG</p> <p>Initial Priority settings: [High] SIP VMS broadcasting Pattern 1 – 20 [Low] LINE/MIC IN</p> <p>RM</p> <p>Initial Priority settings: [High] Microphone Recorded Audio Pattern 1 – 20 [Low] AUX</p> |
| (2) | SAVE button | Click to save the settings and changes. (See p. 31.) |

[About broadcast switching due to broadcast priority settings]

By assigning a higher priority to a broadcast sound source, it can be set to interrupt other broadcasts. Shown below are some representative examples:

Tip

The Patterns described below represent broadcasts made by executing the pattern list set on the Pattern Registration screen. The pattern list includes the combinations of selections and repeated play of sound sources, as well as delay, interval, input volume, enabling or disabling of control outputs, etc.

Internal sound source broadcast switching operations

Example 1. When the signal mode is set to Edge:

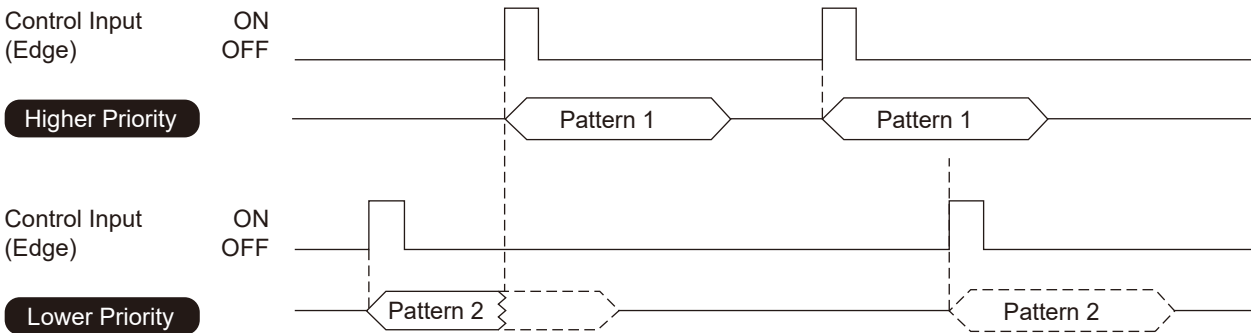

Lower priority broadcasts will be interrupted by higher priority broadcasts.

Lower priority broadcast triggers received during higher priority broadcasts will not be executed.

Example 2. When the signal mode is set to Level:

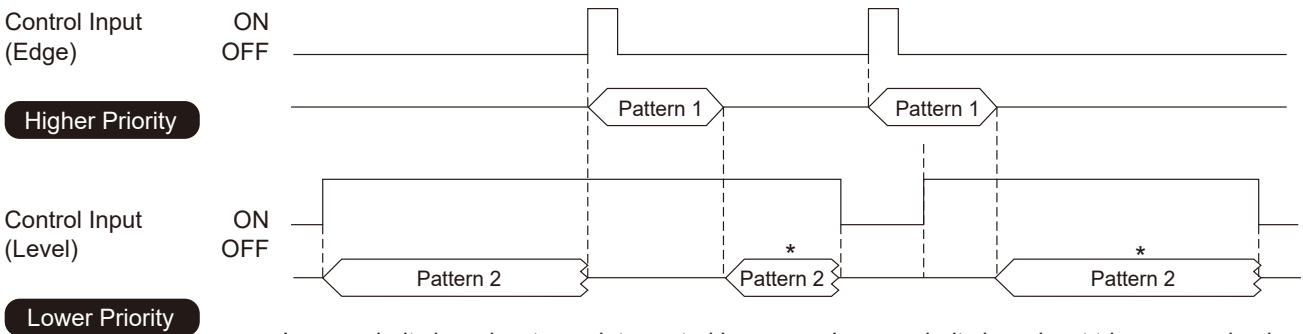

Lower priority broadcasts are interrupted by higher priority broadcasts. If the Level signal input is maintained, the interrupted broadcast will be restored after the higher priority broadcast ends.

Lower priority broadcast triggers received during higher priority broadcasts will not be executed. If the Level signal input is maintained after the higher priority broadcast ends, the lower priority broadcast will be enabled after the higher priority broadcast ends.

RM

* If SIP Target is selected as the broadcast destination, the broadcast is not resumed after higher priority broadcasts end.

Switching operation of Analog Sound Source Broadcasting (LINE/MIC IN)

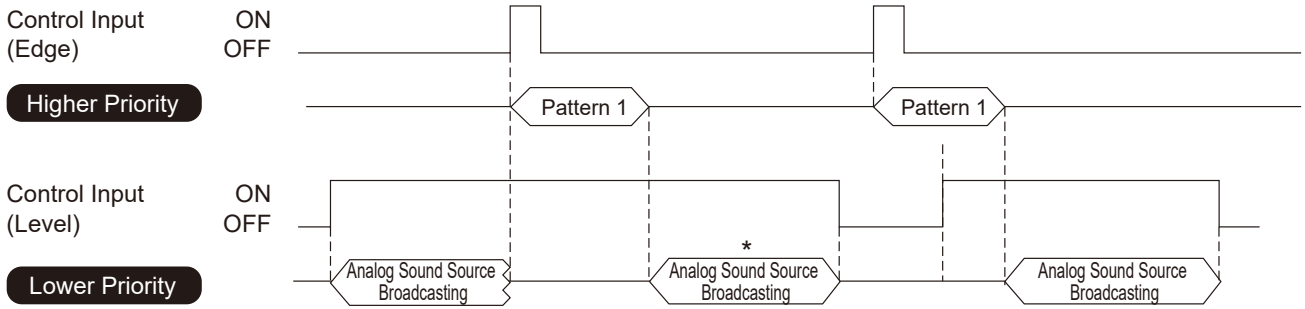

Analog Sound Source Broadcasting, which is low in priority, can be interrupted by higher priority broadcasts. It will resume after the higher priority broadcasts is complete, provided the Level signal is still present.

The trigger for lower priority Analog Sound Source Broadcasting is not executed if initiated during a higher priority broadcasting. The lower priority Analog Sound Source Broadcast will resume if the Level signal is still present after completion of the higher priority broadcast.

RM

* If SIP Target is selected as the broadcast destination, the broadcast is not resumed after higher priority broadcasts end.

SIP and VMS broadcast switching operations

PG

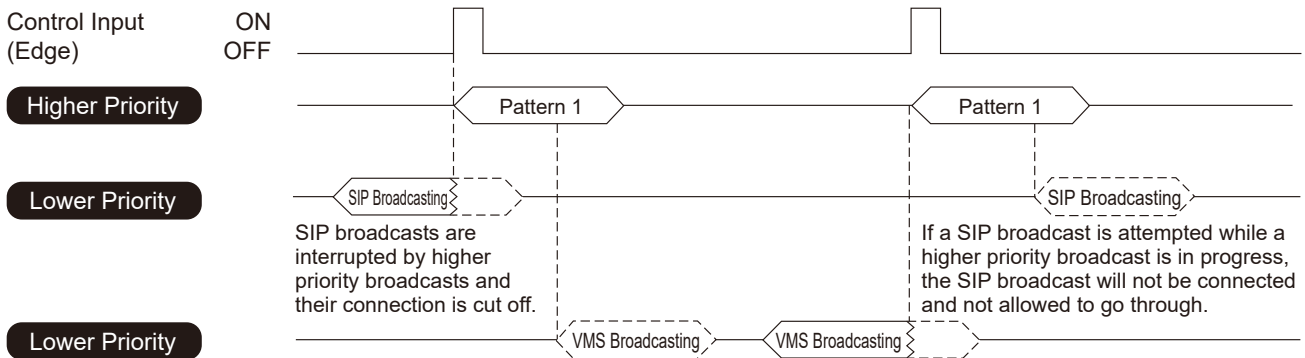

SIP broadcasts are interrupted by higher priority broadcasts and their connection is cut off.

If a SIP broadcast is attempted while a higher priority broadcast is in progress, the SIP broadcast will not be connected and not allowed to go through.

If a VMS broadcast is attempted while a higher priority broadcast is in progress, the VMS broadcast will not be connected and not allowed to go through.

VMS broadcasts are stopped by higher priority broadcasts and their connection is cut off.

20. COMMAND LIST SCREEN

The registration of HTTP commands allows the transmitting device to work in close coordination with any equipment that is capable of HTTP control.

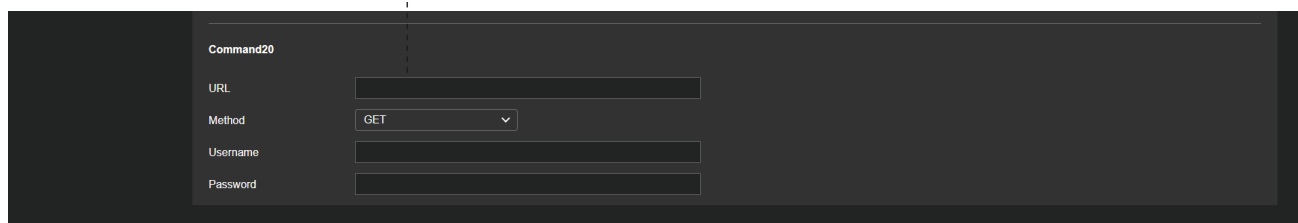
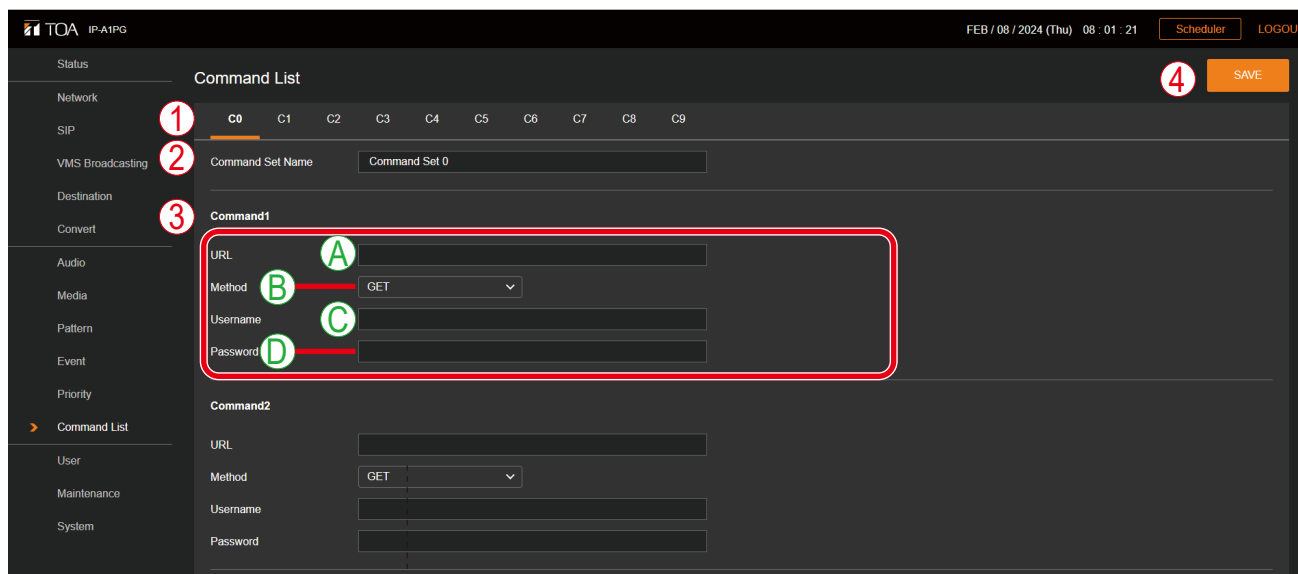

[When POST is selected in the Method (B) of Command setting (3)]

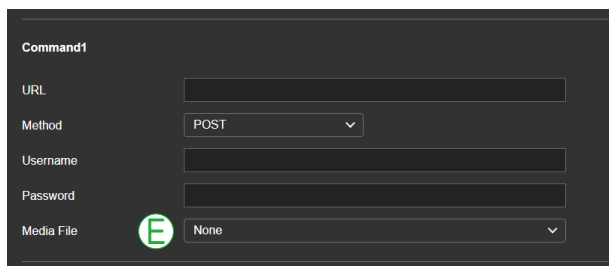

20.1. Command List Makeup

The makeup of each command and command set from the Command List are as follows. Commands can be preset in command set units to execute actions in the Event settings or the Scheduler.

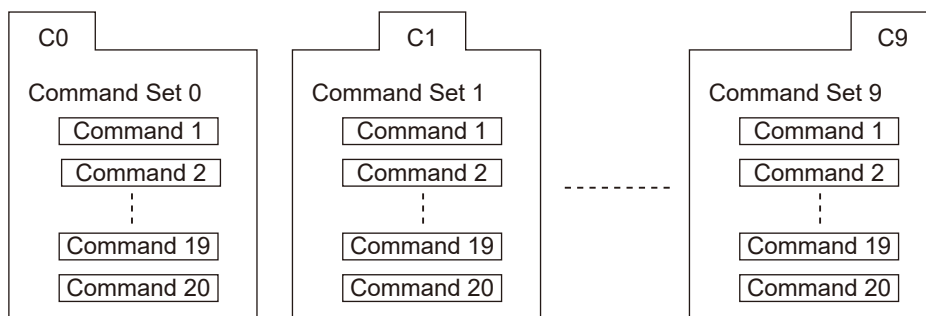

(1) Command set tabs (C0 – C9)

Ten separate Command sets (C0 – C9) are made available. The Command set screen changes as the tabs are selected. Up to 20 commands can be registered for each Command set tab.

(2) Command Set Name

Names can be assigned to each set commands. The full selection of commands is displayed on the Event (and other related) Settings screen(s) using these assigned names.

(3) Command

| | Item | Contents |
|---|------------|--|
| A | URL* | Enter the HTTP command to be registered. Initial setting: Blank |
| B | Method | Select GET or POST as the HTTP command method. GET: The GET selection allows requests to be transmitted. POST: The POST selection allows requests to be transmitted. Use this method to upload the transmitting device's internal sound source file to a designated receiving device. Please refer to "Remote API Specifications" for the specific URL. For more information on "Remote API Specifications," please contact your nearest TOA subsidiary. Initial setting: GET |
| C | Username* | Enter the user name to be used for authentication of the HTTP command's transmission destination. Initial setting: Blank |
| D | Password* | Enter the password to be used for authentication of the HTTP command's transmission destination. Initial setting: Blank |
| E | Media File | This selection is enabled when POST is selected in the Method (B). Select a sound source file to be uploaded from either the internal sound file or recorded sound source RM to the receiving device using the corresponding HTTP command. |

* For more information on the characters or number of characters that can be set, please refer to "[USABLE CHARACTERS](#)" on p. 90.

(4) SAVE button

Click to save the settings and changes. (See p. 31.)

21. USER SETTINGS SCREEN

The username and password required to make a connection to the device from a PC can be set on this screen.

Tip

Administrator privileges allow one to edit all settings and Scheduler functions.

With User privileges, only Scheduler functions can be edited after logging in to the Scheduler screen.

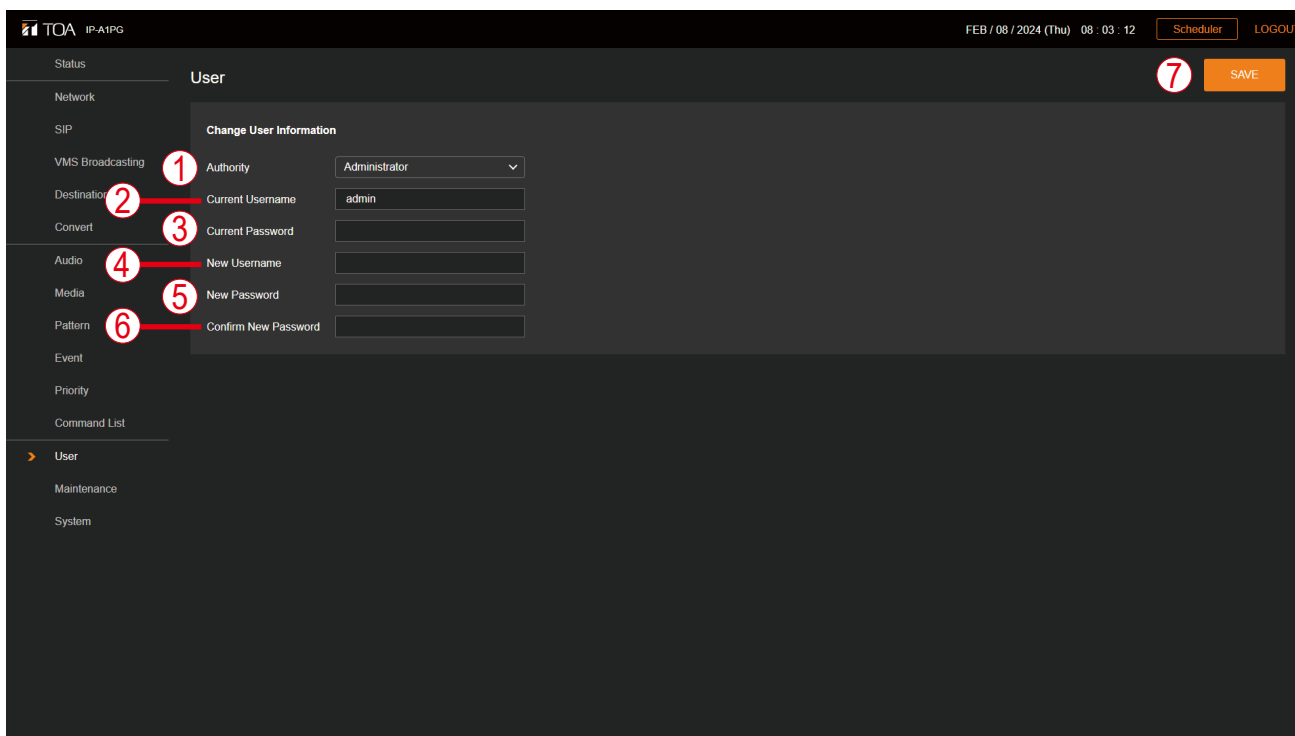

| | Item | Contents |
|-----|---|---|
| (1) | Authority | Selects the level of authority required for making changes to user information, including user names and passwords. Administrator: Changes the user information to enable Administrator privileges. User: Changes the user information to enable User privileges. |
| (2) | Current Username* ¹ , * ² | Enter the current user account name. Initial setting: admin |
| (3) | Current Password* ¹ , * ² | Enter the current user account password. Initial setting: guest |
| (4) | New Username* ¹ | Enter the new user account name. |
| (5) | New Password* ¹ | Enter the new user account password. |
| (6) | Password Confirmation* ¹ | Enter the new user account password once again. |
| (7) | SAVE button | Click to save the settings and changes. (See p. 31.) |

*¹ For more information on the characters or number of characters that can be set, please refer to "[USABLE CHARACTERS](#)" on [p. 90.](#)

*² This item's original setting value is retained when the setting file is uploaded.

22. MAINTENANCE SCREEN

Backup and restoration of device settings data, reset setting, firmware update and hardware reboot can all be performed on this screen.

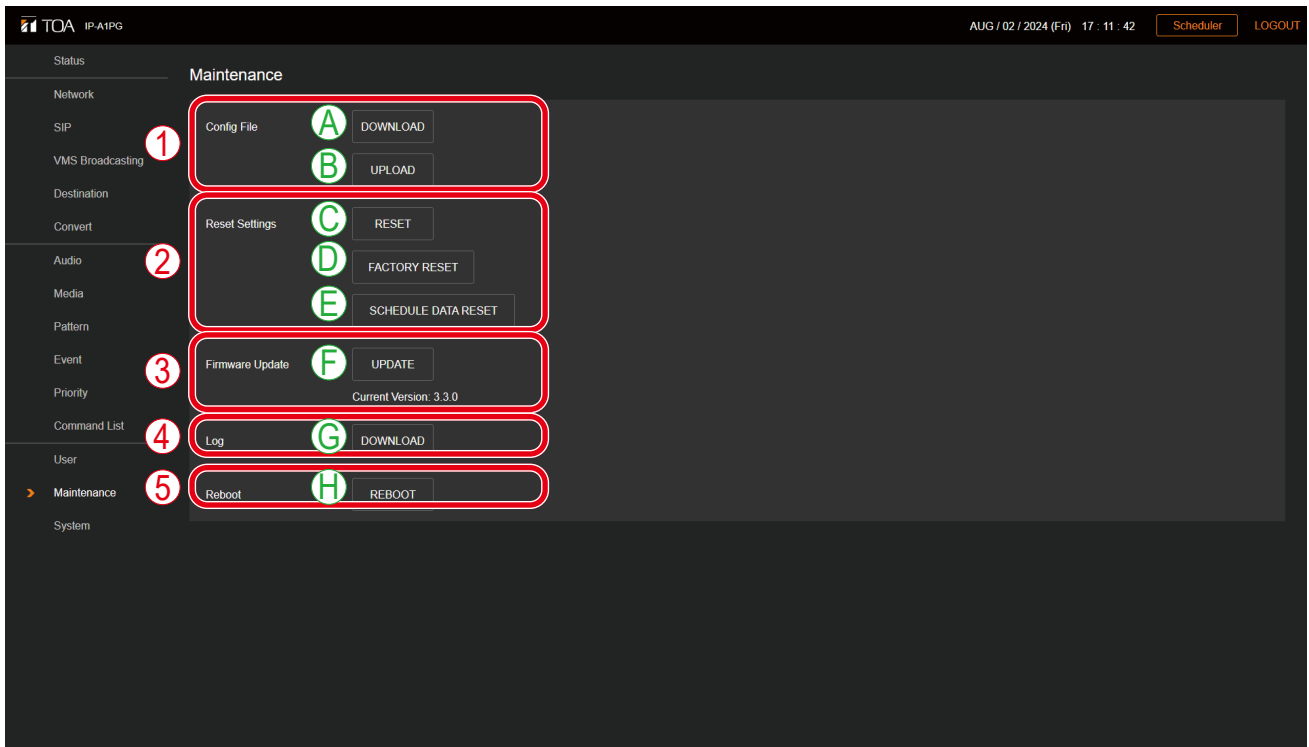

(1) Config File

| | Item | Contents |
|---|----------|---|
| A | DOWNLOAD | The device's settings and sound source files can be downloaded to a connected PC as a single setting file. |
| B | UPLOAD | By uploading the previously downloaded setting file from the PC, the settings and sound source files can be restored to their previous state. Notes <ul style="list-style-type: none"> • User and network settings are not applied to setting file uploads. These settings prior to upload are maintained. • With the exception of Schedule data, any and all configuration data can be selected when uploading the Configuration file. For details, please refer to "Uploading Setting File" on p. 79. |

(2) Reset Setting

| | Item | Contents |
|---|---------------------|---|
| C | RESET | Resets all of the device's settings to their initial setting status. However, sound source files saved within the device are retained on the Media Settings screen without being deleted. |
| D | FACTORY RESET | Resets all of the device's settings to their initial status as shipped from the factory. Internally saved sound source files will also be deleted. |
| E | SCHEDULE DATA RESET | Only resets the device's Schedule data. Other settings are not changed. |

(3) Firmware Update

| | Item | Contents |
|---|--------|---|
| F | UPDATE | The device's firmware can be updated by running the firmware-updater previously saved to the connected PC. The device's current firmware version is displayed in the Current Version box. |

(4) Log

| | Item | Contents |
|---|----------|--|
| G | DOWNLOAD | The device's operation logs can be downloaded to a PC. |

(5) Reboot

| | Item | Contents |
|---|--------|---|
| H | REBOOT | Restarts the device. Use this button when applying setting changes or performing other operations that require restart. |

22.1. Downloading Setting File

Follow the procedure below to save the device's setting contents and sound source files to the PC as setting files:

Step 1. Click on the DOWNLOAD button.
The file explorer opens.

Step 2. Select the folder into which the setting file is to be saved.

Step 3. Enter the filename and click on the SAVE button.

Tip

The setting file extension is ".spconf".

The following filename is automatically assigned when downloading:

<IP address>_<terminal name>.spconf

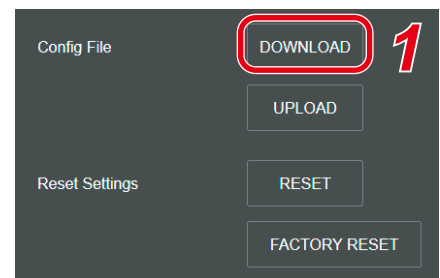

22.2. Uploading Setting File

Follow the procedure below to restore setting contents and sound source files to the device from the setting files saved on the PC.

Note

Performing uploads during a broadcast will stop all current broadcasts.

Step 1. Click on the UPLOAD button.

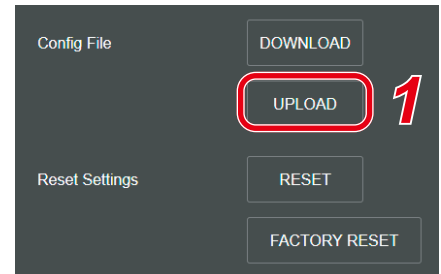

The settings upload screen opens.

Step 2. Click on the Browse button.

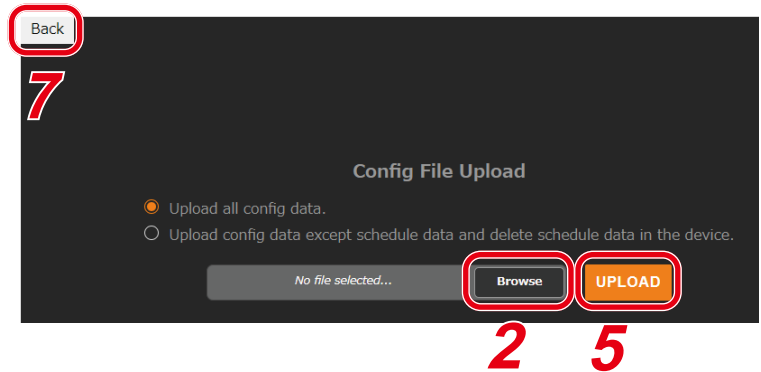

The file explorer opens.

Step 3. Select the setting file.

Tips

- The setting file extension is ".spconf".
- For valid characters that can be used in the file name, please refer to ["USABLE CHARACTERS" on p. 90.](#)

Step 4. Click on the OPEN button.

Step 5. Confirm the setting filename displayed on the screen, then click on the UPLOAD button. Upload begins, followed by an automatic restart. A popup window showing the operating status is displayed during upload or restart. During this process, a confirmation dialog is temporarily displayed when upload of the setting file is complete.

Note

The receiving device's settings file cannot be uploaded to the transmitting device.

Tips

The application range of the Configuration file can be selected before uploading.

- Upload all config data (default value):
Applies all configuration data to the Configuration file to be uploaded.
- Upload config data except schedule data and delete schedule data in the device:
With the exception of the Schedule data, applies the selected configuration data to the Configuration files to be uploaded. If Schedule data has already been registered to the device, the device's Schedule data will be deleted.

Step 6. Click on the OK button.

After restart is complete, the popup window showing the operating status turns off, returning the display to the Settings Upload screen.

Step 7. Click on the Back button located at the upper left of the Settings upload screen. The display then reverts to the Login screen.

22.3. Initialization of Settings

Follow the procedure below to return all the device's setting contents to their initial settings.

Notes

- Unlike the factory default settings procedure described on the following page, the device's saved sound source files are not deleted.
- The firmware version does not revert to the factory-preset version. The version that existed before settings initialization is maintained.

Step 1. Click on the RESET button.

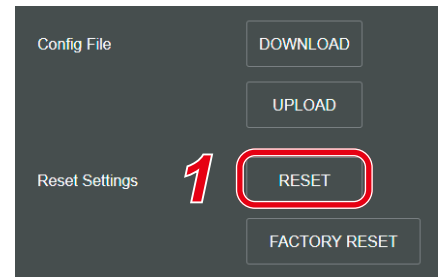

The dialog box opens.

Step 2. Click on the YES button.

The initialization of all the device's settings begins.
The dialog box is displayed when initialization is completed.



Step 3. Click on the OK button.

Step 4. Restart the device.

If Restart is executed, all of the device's new settings will be initialized after the device is restarted.
For the restart method, please refer to "[Restarting the Device](#)" on p. 32.

Tip

Settings can also be initialized by using the device's Reset key. For detailed setting procedure, please refer to the instruction manual supplied with the device.

22.4. Factory Default Settings

Follow the procedure below to return all the device's settings to their factory-preset condition.

Notes

- If returned to factory default settings, all of the sound source files saved in the device will also be deleted.
- The firmware version does not revert to the factory-preset version. The version that existed before settings initialization is maintained.

Step 1. Click on the FACTORY RESET button.

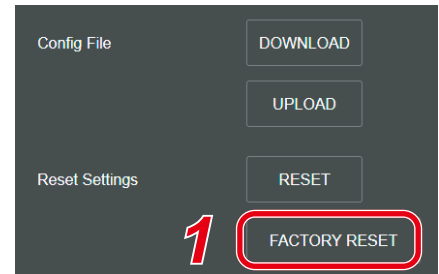

The dialog box opens.

Step 2. Click on the YES button.
Initialization to factory default setting begins.
The dialog box is displayed once initialization is complete.

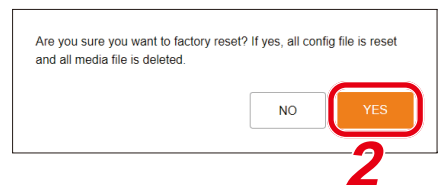

Step 3. Click on the OK button.

Step 4. Restart the device.
If Restart is executed, the device will revert to its initial factory-preset condition after being restarted.
For the restart procedure, please refer to ["Restarting the Device" on p. 32.](#)

22.5. Firmware Update

The procedure for updating the device's firmware is as follows:

Tip

Download the latest firmware-updater after performing a search of the TOA DATA Library (<https://www.toa-products.com/international/>) for the product number.

Note

Do not change the filename of the downloaded firmware-updater.

Step 1. Click on the UPDATE button.



The Update screen opens.

Step 2. Click on the Browse button.
The file explorer opens.

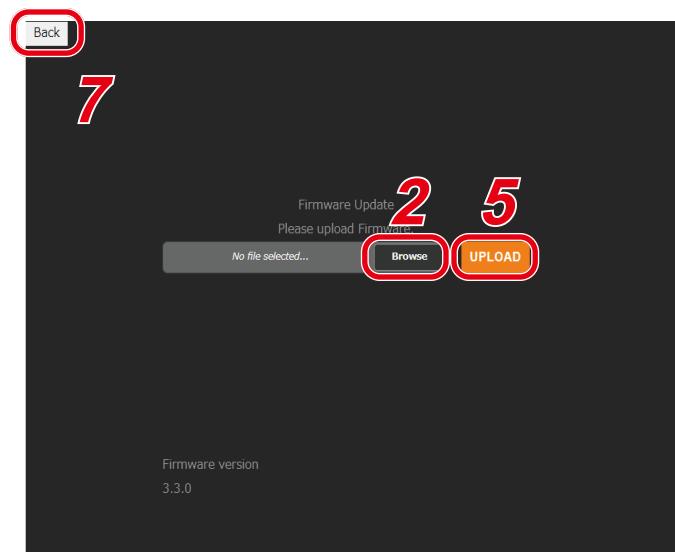

Step 3. Select the new firmware-updater file.

Tip

The firmware-updater's extension is ".bin".

Step 4. Click on the OPEN button.

Step 5. Confirm the firmware-updater's name displayed on the screen, then click on the UPLOAD button.
The dialog box is displayed.

Step 6. Click on the OK button.

Upload of the new firmware-updater begins.

After upload is completed, the device's Status indicator changes to indicate that the firmware update is in progress, and the device is restarted.

After restart is completed, the display reverts to the Update screen.

Note

Do not restart the device or turn off its power during firmware update, as doing so could result in corrupted firmware, potentially making it impossible to start the device.

Step 7. Click on the Back button located at the upper left of the Update screen.
The display reverts to the Login screen.

Step 8. After logging in again, confirm that the new firmware version is displayed in the Firmware Version field on the Status screen.

Tip

After firmware update, all settings and sound source files are maintained without being initialized.

22.6. Downloading the Log File

22.6.1. About the Log File

Clicking on the DOWNLOAD button in the Log field allows the log file to be downloaded. The file name extension is [.log]. The log can be browsed using a text editor like Notepad. The following filename is automatically assigned when downloading: <IP address>_<terminal name>.log

Data saved to the log file includes device information and operating log.

Logs are kept for 30 days.

File size can be up to about 15MB.



| | | | |
|--------------------------------|--------------------------------|--------------------------|--------------------------------|
| Device information | [TERMINAL] | (Model) | IP-A1AF |
| | [TERMINAL] | (HW version) | 1 |
| | [TERMINAL] | (MAC Address) | 00:05:f9:xx:xx:xx |
| | [TERMINAL] | (Name) | IP-A1AF |
| | [TERMINAL] | (FW version) | x.x.x |
| | [TERMINAL] | (IP Address) | 192.168.14.1 |
| | [TERMINAL] | (Subnet Mask) | 255.255.255.0 |
| | [TERMINAL] | (Default Gateway) | 0.0.0.0 |
| | [TERMINAL] | (DNS Server (Primary)) | 0.0.0.0 |
| | [TERMINAL] | (DNS Server (Secondary)) | 0.0.0.0 |
| Operating log | ----- log ----- | | |
| | [2024/08/22 14:41:57 UTC+0900] | [SYSTEM] | Start Up |
| | [2024/08/22 14:42:00 UTC+0900] | [AUDIO] | Speaker Volume -30 dB |
| | [2024/08/22 14:42:00 UTC+0900] | [AUDIO] | Speaker Mute Disable |
| | [2024/08/22 14:42:00 UTC+0900] | [AUDIO] | LINE/MIC IN Mute Disable |
| | [2024/08/22 14:42:00 UTC+0900] | [AUDIO] | LINE/MIC IN Sensitivity 0.0 dB |
| | [2024/08/22 14:42:18 UTC+0900] | [SYSTEM] | Broadcast Function Ready |
| | [2024/08/22 14:42:19 UTC+0900] | [STATUS] | Idle |
| [2024/08/22 14:43:04 UTC+0900] | [STATUS] | Pattern 1 | |
| [2024/08/22 14:43:07 UTC+0900] | [STATUS] | Idle | |

22.6.2. Log Table

| Transmitting Device Log | Variable | Log Contents |
|---|---|---|
| [SYSTEM] | | |
| Start Up | | Transmitting device started |
| Broadcast Function Ready | | Broadcast ready |
| Reboot | | Restarted |
| Changing Date and Time | | Start of changing date and time settings |
| Change Date and Time | | Date and time settings changed |
| NTP Synchronization Start | | NTP time synchronization ON |
| NTP Synchronized (NTP Server #) | NTP server number (1, 2) | NTP time synchronization successful |
| NTP Synchronization is skipped (The status is not Idle) | | NTP time synchronization skipped — Device not in idle state |
| [ERROR] NTP Synchronization Failed | | NTP time synchronization failed |
| [STATUS] | | |
| Idle | | Standby mode ON |
| SIP DTMF Waiting | | DTMF number input waiting mode started |
| SIP to Multicast ## | Multicast channel number (1 – 20) | SIP audio multicast transmission started |
| VMS to Multicast ## | Multicast channel number (1 – 20) | VMS audio multicast transmission started |
| LINE/MIC IN to Multicast ## | Multicast channel number (1 – 20) | Analog audio multicast transmission started |
| AUX to Multicast ## | Multicast channel number (1 – 20) | AUX broadcast (Multicast transmission) |
| AUX to SIP Calling | | AUX broadcasting (SIP Calling) |
| AUX to SIP | | AUX broadcasting (SIP) |
| Microphone to Multicast ## | Multicast channel number (1 – 20) | Microphone broadcasting (Multicast transmission) |
| Microphone to SIP Calling | | Microphone broadcasting (SIP Calling) |
| Microphone to SIP | | Microphone broadcasting (SIP) |
| Pattern ## to Multicast ## | Pattern number (1 – 20) Multicast channel number (1 – 20) | Pattern audio multicast transmission started |
| Pattern ## to SIP Calling | Pattern number (1 – 20) | Pattern broadcast (SIP Calling) |
| Pattern ## to SIP | Pattern number (1 – 20) | Pattern broadcast (SIP) |
| Broadcast Disable | | Broadcast suspension mode started |
| System Mute | | System mute ON |
| [AUDIO] | | |
| LINE/MIC IN Sensitivity ## dB | Sensitivity setting value (0.0 – 12.0) | Audio input sensitivity settings changed |
| LINE/MIC IN Mute Enable | | Audio input mute ON |
| LINE/MIC IN Mute Disable | | Audio input mute OFF |
| MIC IN Sensitivity ## dB | Sensitivity setting value (0.0 – 12.0) | Audio input sensitivity settings changed |
| MIC IN Mute Enable | | Audio input mute ON |
| MIC IN Mute Disable | | Audio input mute OFF |
| AUX IN Sensitivity ## dB | Sensitivity setting value (0.0 – 12.0) | Audio input sensitivity settings changed |
| AUX IN Mute Enable | | Audio input mute ON |
| AUX IN Mute Disable | | Audio input mute OFF |
| Speaker Volume ## (**) | ##: Speaker volume value (–60 dB – 0 dB, mute) **: Speaker volume level (0 – 10) | Speaker volume adjustment |
| [EVENT] | | |
| Control In # ON (Edge) | Control-in number (1 – 4) | Control input turned ON as Edge signal |
| Control In # ON (Level) | Control-in number (1 – 4) | Control input turned ON as Level signal |
| Control In # OFF (Level) | Control-in number (1 – 4) | Control input turned OFF as Level signal |

| Transmitting Device Log | Variable | Log Contents |
|--|--|---|
| [ACTION] | | |
| No Action | | Action to be executed not set |
| Pattern ## Start | Pattern number (1 – 20) | Internal sound source broadcasting ON |
| Pattern ## End | Pattern number (1 – 20) | Internal sound source broadcasting OFF (only if Level signal) |
| LINE/MIC IN Start | | Analog audio broadcasting started |
| LINE/MIC IN End | | Analog audio broadcasting completed |
| AUX Start | | Analog audio broadcasting started |
| AUX End | | Analog audio broadcasting completed |
| Command Set # | Command set number (0 – 9) | Command set transmission executed |
| Broadcast Disable Start | | Broadcast suspension mode started |
| Broadcast Disable End | | Broadcast suspension mode ended |
| System Mute Start | | System mute ON |
| System Mute End | | System mute OFF |
| [MAINTENANCE] | | |
| Download Config | | Setting file download ON |
| Upload Config | | Setting file upload ON |
| Reset Settings | | Setting reset executed |
| Reset Schedules | | Schedule reset executed |
| Download Log | | Log download ON |
| Firmware Update (xxx => yyy) | xxx: Version before updating yyy: Updated version | Firmware update ON |
| [SCHEDULE] | | |
| Pattern ## to Multicast ## Start | Pattern number (1 – 20) Multicast channel number (1 – 20) | Internal sound source broadcasting started |
| Pattern ## to Multicast ## End | Pattern number (1 – 20) Multicast channel number (1 – 20) | Internal sound source broadcasting stopped |
| Pattern ## to SIP (target) DTMF dtmf Start Pattern ## to SIP (target) Start (when without DTMF) | target: SIP calling destination dtmf: DTMF number | Pattern to SIP started |
| Pattern ## to SIP (target) DTMF dtmf End Pattern ## to SIP (target) End (when without DTMF) | target: SIP calling destination dtmf: DTMF number | Pattern to SIP stopped |
| LINE/MIC IN to Multicast ## Start | Multicast channel number (1 – 20) | Analog audio broadcasting started. |
| LINE/MIC IN to Multicast ## End | Multicast channel number (1 – 20) | Analog audio broadcasting stopped. |
| AUX to Multicast ## Start | Multicast channel number (1 – 20) | Analog audio broadcasting started. |
| AUX to Multicast ## End | Multicast channel number (1 – 20) | Analog audio broadcasting stopped. |
| AUX to SIP (target) DTMF dtmf Start AUX to SIP (target) Start (when without DTMF) | target: SIP calling destination dtmf: DTMF number | AUX to SIP started. |
| AUX to SIP (target) DTMF dtmf End AUX to SIP (target) End (when without DTMF) | target: SIP calling destination dtmf: DTMF number | AUX to SIP ended |
| Command Set # | Command set number (0 – 9) | Execution of command set transmission. |
| Control Out ON | | Control output ON |
| Control Out OFF | | Control output OFF |
| New Schedule (id=xxx) | xxx: Schedule ID | New Schedule creation |
| Edit Schedule (id=xxx) | xxx: Schedule ID | Schedule editing enabled |
| Edit Schedule (id=xxx=>id=xxx,yyy) | xxx: Schedule ID before dividing yyy: Devided schedule ID | Schedule division |

| Transmitting Device Log | Variable | Log Contents |
|--|---|--|
| Remove Schedule (id=xxx) | xxx: Schedule ID | Schedule deleted |
| Edit Categories | | Category editing enabled |
| Edit Schedules (category=zzz) | zzz: Category ID | Batch editing of repeat settings from category |
| Maintenance Start | | Deleting expired schedules started. |
| Maintenance End | | Deleting expired schedules completed. |
| [KEY] | | |
| Pattern ## to Multicast ## Start | Pattern number (1 – 20) Multicast channel number (1 – 20) | Internal sound source broadcasting started |
| Pattern ## to SIP (target) DTMF dtmf Start Pattern ## to SIP (target) Start (when without DTMF) | target: SIP calling destination dtmf: DTMF number | Pattern to SIP started |
| Pattern ## Broadcasting End | Pattern number (1 – 20) | Pattern broadcasting stopped |
| Microphone to Multicast ## Start | Multicast channel number (1 – 20) | Microphone to Multicast started |
| Microphone to SIP (target) DTMF dtmf Start Microphone to SIP (target) Start (when without DTMF) | target: SIP calling destination dtmf: DTMF number | Microphone to SIP started |
| Microphone Broadcasting End | | Microphone Broadcasting ended |
| AUX to Multicast ## Start | Multicast channel number (1 – 20) | AUX to Multicast started |
| AUX to SIP (target) DTMF dtmf Start AUX to SIP (target) Start (when without DTMF) | target: SIP calling destination dtmf: DTMF number | AUX to SIP started |
| AUX Broadcasting End | | AUX broadcasting completed |
| Recorded Audio to Multicast ## Start | Multicast channel number (1 – 20) | Recorded audio to Multicast started |
| Recorded Audio to SIP (target) DTMF dtmf Start Recorded Audio to SIP (target) Start (when without DTMF) | target: SIP calling destination dtmf: DTMF number | Recorded audio to SIP started |
| Recorded Audio Broadcasting End | | Recorded audio to SIP stopped |
| Microphone Recording Start | | Microphone recording started |
| Microphone Recording Stop | | Microphone recording stopped |
| Recorded Audio Confirmation Start | | Confirming recorded audio started |
| Recorded Audio Confirmation Stop | | Confirming recorded audio stopped |
| Pattern ## Confirmation Start | Pattern number (1 – 20) | Confirming pattern broadcast started |
| Pattern ## Confirmation Stop | Pattern number (1 – 20) | Confirming pattern broadcast stopped |
| AUX Confirmation Start | | Confirming AUX broadcast started |
| AUX Confirmation Stop | | Confirming AUX broadcast stopped |
| Delete Recorded Audio | | Deleting recorded audio completed |
| Command Set ## | Command set number (0 – 9) | Command set transmission executed |
| Control Out ON | | Control output turned ON |
| Control Out OFF | | Control output turned OFF |
| Lock Key | | Key is locked (including auto key lock) |
| Unlock Key | | Key is unlocked |
| [SIP] | | |
| SIP Server State (xxx) | xxx: Unregistered Registering Registered | SIP Registration Status for error case |
| SIP Server State (xxx) [yyy:zzz] | xxx: Registration Failed yyy: Error Message zzz: SIP Response Code | SIP Registration Status for error case |

| Transmitting Device Log | Variable | Log Contents |
|--|--|-------------------------|
| Outgoing (xxx) (yyy) | xxx: Trying Remote Ringing Connected DTMF sent [char*] (RM only) DTMF response received [char*] (RM only) End yyy: Remote SIP ID | SIP outgoing call state |
| Outgoing (xxx) (yyy) [aaa:zzz] | xxx: Error yyy: Remote SIP ID aaa: SIP Error Message zzz: SIP response code | SIP outgoing call state |
| Incoming (xxx) (yyy) | xxx: Ringing Connected DTMF received [char*] (PG only) DTMF response sent [char*] (PG only) High Priority Call Accepted (except RM) Low Priority Call Rejected (except RM) End yyy: Remote SIP ID | SIP incoming call state |
| Incoming (xxx) (yyy) [aaa:zzz] | xxx: Error yyy: Remote SIP ID aaa: SIP Error message zzz: SIP response code | SIP incoming call state |
| [COMMAND LIST] | | |
| Command Set n Sent, Total=x (OK=y Error=z) | n: Command Set number (0 – 9) x: Total number of commands y: Number of OK commands z: Number of OK commands | Commands result |
| [ERROR] Command Set n Command m (No Response) | n: Command Set number (0 – 9) m: Command number (1 – 20) | No Response |
| [ERROR] Command Set n Command m (Response Code: xxx) | n: Command Set number (0 – 9) m: Command number (1 – 20) xxx: Response code | Error Response |

* Setting range: 0 – 9, *, #, A, B, C, D

23. SYSTEM SETTINGS SCREEN

Perform date and time and NTP server synchronization settings.

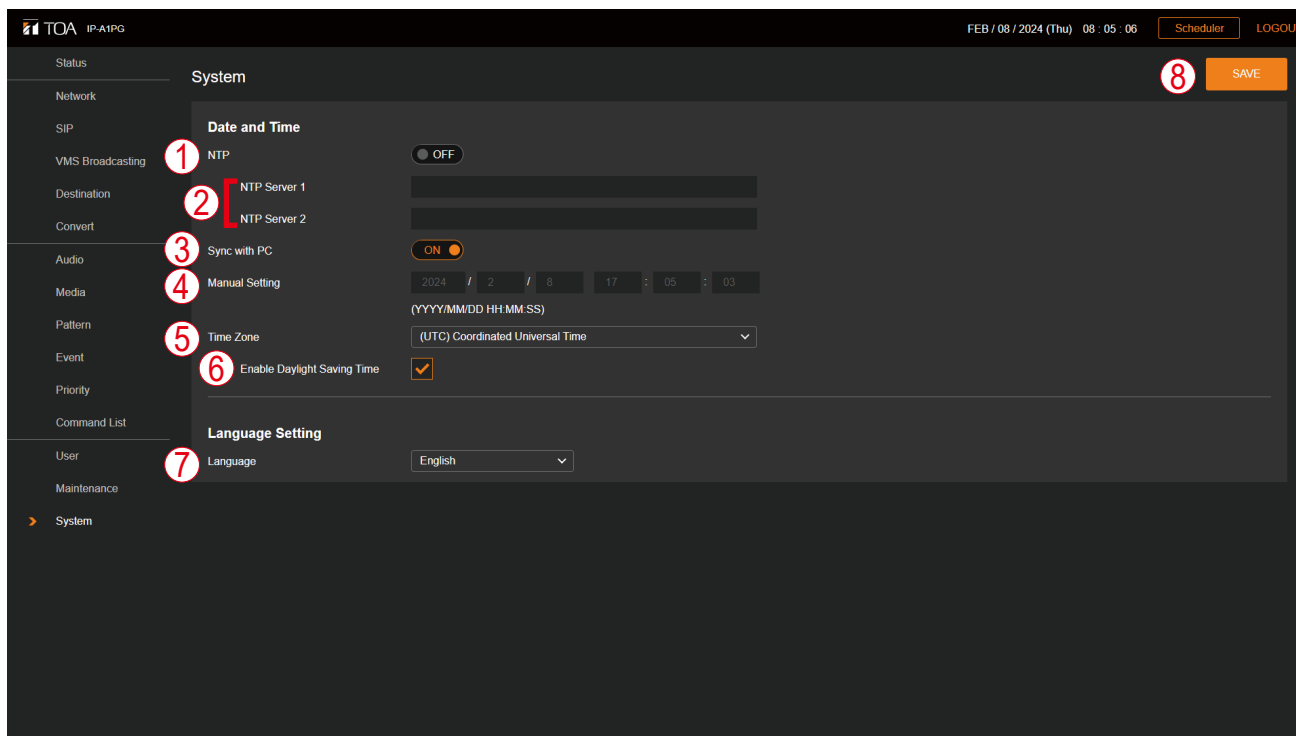

For the setting method, please refer to ["CURRENT DATE AND TIME SETTINGS"](#) on p. 28.

| | Item | Contents |
|-----|-----------------------------|--|
| (1) | NTP | Setting NTP to ON enables the NTP client function. If a synchronous operation to the NTP server begins, the following contents are displayed: Synchronizing...: NTP synchronization in progress. Synchronized: NTP synchronization succeeded. Synchronization Failed: NTP synchronization failed. Initial setting: OFF Note No synchronization is possible if the receiving device is currently broadcasting. |
| (2) | NTP Server 1, 2* | Enter the NTP server's IP address or domain to select the server to be synchronized. Initial setting: Blank space |
| (3) | Sync with PC | If this function is set to ON and the SAVE button (8) is clicked, the device's clock will synchronize with that of the connected PC. This setting is enabled when NTP (1) is set to OFF. Initial setting: ON |
| (4) | Manual Setting | Set the current time manually. The time is set when the SAVE button (8) is clicked. This setting is enabled when both NTP (1) and Sync with PC (3) are set to OFF. |
| (5) | Time Zone | Select the time zone of the location where the device is installed. This location will be set when the SAVE button (8) is clicked. Initial setting: (UTC) Coordinated Universal Time |
| (6) | Enable Daylight Saving Time | Checking this box enables daylight saving time correction in time zones where daylight saving time (DST) is applicable. In time zones where daylight saving time is not used, this time correction is not enabled, regardless of whether the box is checked or not. Initial setting: Checked |
| (7) | Language | The display language on setting screen in the web browser, and on the LCD screen of the IP-A1RM can be set. Initial setting: English |
| (8) | SAVE button | Click to save the settings and changes. (See p. 31.) |

* For more information on the characters or number of characters that can be set, please refer to ["USABLE CHARACTERS"](#) on p. 90.

Note

By powering the device for a period of 24 hours or more, the time can be retained for approximately 24 hours in an unpowered state. The current time is not retained in such cases as immediately after the device was purchased or if the device has not been powered for long periods of time. Please make sure to set the current time immediately after purchasing and switching ON the device.

24. USABLE CHARACTERS

24.1. Characters That Can Be Used for Names, Authentication ID and Passwords

| Target | | Max. number of characters | Alphabetical A – Z a – z | Numerical 0 – 9 | Allowable symbols |
|----------------------------------|---------------------|---------------------------|--------------------------------|--------------------|--|
| Login screen | Username | 15 | ✓ | ✓ | × Symbols cannot be used. |
| | Password | 15 | ✓ | ✓ | |
| Key settings screen | Key name | 32 | ✓ | ✓ | “ ” space “.” colon “!” exclamation “;” semicolon “#” hash “<” “>” unequal sign “\$” dollar “=” equal “%” percent “?” question “&” ampersand “@” at sign “'” apostrophe “[” “]” square bracket “(” “)” parentheses “^” hat “*” asterisk “_” underscore “+” plus “`” back quote “,” comma “{” “}” curly bracket “-” hyphen “ ” vertical bar “.” dot “~” tilde “/” slash |
| Network settings screen | Terminal Name | 31 | ✓ | ✓ | “!” exclamation “-” hyphen “#” hash “@” at sign “\$” dollar “[” “]” square bracket “%” percent “^” hat “&” ampersand “_” underscore “'” apostrophe “{” “}” curly bracket “(” “)” parentheses “~” tilde |
| SIP settings screen | SIP Server Address | 253*1 | ✓ | ✓ | “-” hyphen “.” dot |
| | User ID | 31 | ✓ | ✓ | “-” hyphen “_” underscore |
| | Display Name | 31 | ✓ | ✓ | |
| | Password | 31 | ✓ | ✓ | “ ” space “.” colon “!” exclamation “;” semicolon “#” hash “<” “>” unequal sign “\$” dollar “=” equal “%” percent “?” question “&” ampersand “@” at sign “'” apostrophe “[” “]” square bracket “(” “)” parentheses “^” hat “*” asterisk “_” underscore “+” plus “`” back quote “,” comma “{” “}” curly bracket “-” hyphen “ ” vertical bar “.” dot “~” tilde “/” slash |
| | Authentication ID | 31 | ✓ | ✓ | “-” hyphen “_” underscore |
| | Priority SIP Client | 31 | ✓ | ✓ | “-” hyphen “_” underscore “.” dot*2 |
| VMS Broadcasting settings screen | Username | 15 | ✓ | ✓ | × Symbols cannot be used. |
| | Password | 15 | ✓ | ✓ | |

| Target | | Max. number of characters | Alphabetical A – Z a – z | Numerical 0 – 9 | Allowable symbols |
|-----------------------------|-------------------------------------|---------------------------|--------------------------------|--------------------|--|
| Destination settings screen | Group Name | 32 | ✓ | ✓ | “ ” space “!” exclamation “#” hash “\$” dollar “%” percent “&” ampersand “'” apostrophe (“ ”) parentheses “*” asterisk “+” plus “,” comma “-” hyphen “.” dot “/” slash “:” colon “;” semicolon “<” “>” unequal sign “=” equal “?” question “@” at sign “[” “]” square bracket “^” hat “_” underscore “`” back quote “{ ” “}” curly bracket “ ” vertical bar “~” tilde |
| Pattern settings screen | Pattern Name | 32 | ✓ | ✓ | “ ” space “!” exclamation “#” hash “\$” dollar “%” percent “&” ampersand “'” apostrophe (“ ”) parentheses “*” asterisk “+” plus “,” comma “-” hyphen “.” dot “/” slash “:” colon “;” semicolon “<” “>” unequal sign “=” equal “?” question “@” at sign “[” “]” square bracket “^” hat “_” underscore “`” back quote “{ ” “}” curly bracket “ ” vertical bar “~” tilde |
| Event settings screen | SIP User ID | 31 | ✓ | ✓ | “-” hyphen “_” underscore “.” dot*2 |
| | Display Name in Control-out section | 32 | ✓ | ✓ | “ ” space “!” exclamation “#” hash “\$” dollar “%” percent “&” ampersand “'” apostrophe (“ ”) parentheses “*” asterisk “+” plus “,” comma “-” hyphen “.” dot “/” slash “:” colon “;” semicolon “<” “>” unequal sign “=” equal “?” question “@” at sign “[” “]” square bracket “^” hat “_” underscore “`” back quote “{ ” “}” curly bracket “ ” vertical bar “~” tilde |
| Command List | Command Set Name | 32 | ✓ | ✓ | “ ” space “!” exclamation “#” hash “\$” dollar “%” percent “&” ampersand “'” apostrophe (“ ”) parentheses “*” asterisk “+” plus “,” comma “-” hyphen “.” dot “/” slash “:” colon “;” semicolon “<” “>” unequal sign “=” equal “?” question “@” at sign “[” “]” square bracket “^” hat “_” underscore “`” back quote “{ ” “}” curly bracket “ ” vertical bar “~” tilde |
| | URL | 2048*1 | ✓ | ✓ | “!” exclamation “#” hash “\$” dollar “%” percent “&” ampersand “'” apostrophe (“ ”) parentheses “*” asterisk “+” plus “,” comma “-” hyphen “.” dot “/” slash “:” dot “/” slash “:” colon “;” semicolon “=” equal “?” question “@” at sign “[” “]” square bracket “_” underscore “~” tilde |
| | Username | 15 | ✓ | ✓ | x Symbols cannot be used. |
| | Password | 15 | ✓ | ✓ | |

| Target | | Max. number of characters | Alphabetical A – Z a – z | Numerical 0 – 9 | Allowable symbols | |
|------------------------|---------------------------------|---------------------------|--------------------------------|--------------------|---|--|
| User settings screen | Current Username | 15 | ✓ | ✓ | x Symbols cannot be used. | |
| | Current Password | 15 | ✓ | ✓ | | |
| | New Username | 15 | ✓ | ✓ | | |
| | New Password | 15 | ✓ | ✓ | | |
| | Confirm New Password | 15 | ✓ | ✓ | | |
| System settings screen | NTP Server 1 | 253* ¹ | ✓ | ✓ | “_” hyphen | |
| | NTP Server 2 | 253* ¹ | ✓ | ✓ | “.” dot | |
| Scheduler | Schedule Settings/Name | 32 | ✓ | ✓ | “ ” space | “:” colon |
| | Category Settings/Category Name | 32 | ✓ | ✓ | “!” exclamation “#” hash “\$” dollar “%” percent “&” ampersand “'” apostrophe “(” “)” parentheses “*” asterisk “+” plus “,” comma “-” hyphen “.” dot “/” slash | “;” semicolon “<” “>” unequal sign “=” equal “?” question “@” at sign “[” “]” square bracket “^” hat “_” underscore “`” back quote “{” “}” curly bracket “ ” vertical bar “~” tilde |

*¹ Please note that a maximum of 63 characters can be used for the label.

*² Can only be used when entering the address.

Tip

Characters that can be used when entering the "Name (Terminal Name)" with the IP settings tool are the same as those used for the [Terminal Name] on the Network Settings screen shown above.

24.2. Characters That Can Be Used for Filenames

| Target | | Max. number of characters | Alphabetical A – Z a – z | Numerical 0 – 9 | Allowed Symbols | |
|-----------------------|-----------------------------------|---------------------------|--------------------------------|--------------------|--|---|
| Media settings screen | Media file name (* .wav* .mp3) | 32* ³ | ✓ | ✓ | “ ” space “!” exclamation “#” hash “\$” dollar “%” percent “&” ampersand “'” apostrophe “(” “)” parentheses “+” plus “,” comma “-” hyphen | “.” dot “;” semicolon “=” equal “@” at sign “[” “]” square bracket “^” hat “_” underscore “`” back quote “{” “}” curly bracket “ ” vertical bar “~” tilde |
| Chime settings screen | Media file name (* .wav* .mp3) | 32* ³ | ✓ | ✓ | “ ” space “!” exclamation “#” hash “\$” dollar “%” percent “&” ampersand “'” apostrophe “(” “)” parentheses “+” plus “,” comma “-” hyphen | “.” dot “;” semicolon “=” equal “@” at sign “[” “]” square bracket “^” hat “_” underscore “`” back quote “{” “}” curly bracket “ ” vertical bar “~” tilde |
| Maintenance screen | Config file name (* .spconf) | 128* ³ | ✓ | ✓ | “ ” space “!” exclamation “#” hash “\$” dollar “%” percent “&” ampersand “'” apostrophe “(” “)” parentheses “+” plus “,” comma “-” hyphen | “.” dot “;” semicolon “=” equal “@” at sign “[” “]” square bracket “^” hat “_” underscore “`” back quote “{” “}” curly bracket “ ” vertical bar “~” tilde |

*³ File extensions are also included in the total number of characters.

Tip

Characters that can be used for filenames when performing "Setting Upload" by means of the IP settings tool are the same as those used for the "Config filename" on the Maintenance screen shown above.

25. THE SCHEDULER

25.1. About the Scheduler Function

25.1.1. Overview

The Scheduler makes possible automatic broadcasts by simply specifying the date and time. It also implements such controls as control output and command transmission. Employing an easy-to-understand user interface, even inexperienced users can operate it intuitively. Additionally, the Scheduler offers a wide variety of editing methods that correspond to various usage conditions, such as batch editing based on schedules, tasks or categories.

25.1.2. Opening the Scheduler Screen

[With Administrator privileges]

Logging in with Administrator privileges displays the settings screen. Click on the Scheduler button at the upper right to display the Scheduler screen.

[With User privileges]

With the Login screen displayed, log in with User privileges to display the Scheduler screen.

Tip

With User privileges, new schedules can be created or schedules edited on the Scheduler screen. However, since changes cannot be made using the Settings screen, such operations as replacing sound source files or changing pattern configurations are not possible. These settings can only be changed with Administrator privileges.

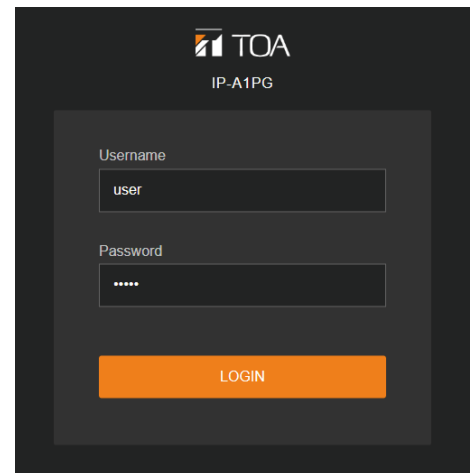
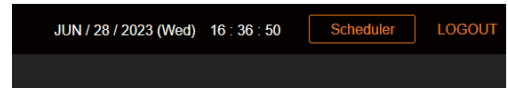

25.1.3. Scheduler Conceptualization and Description of Terms

[Conceptual diagram of Scheduler functions]

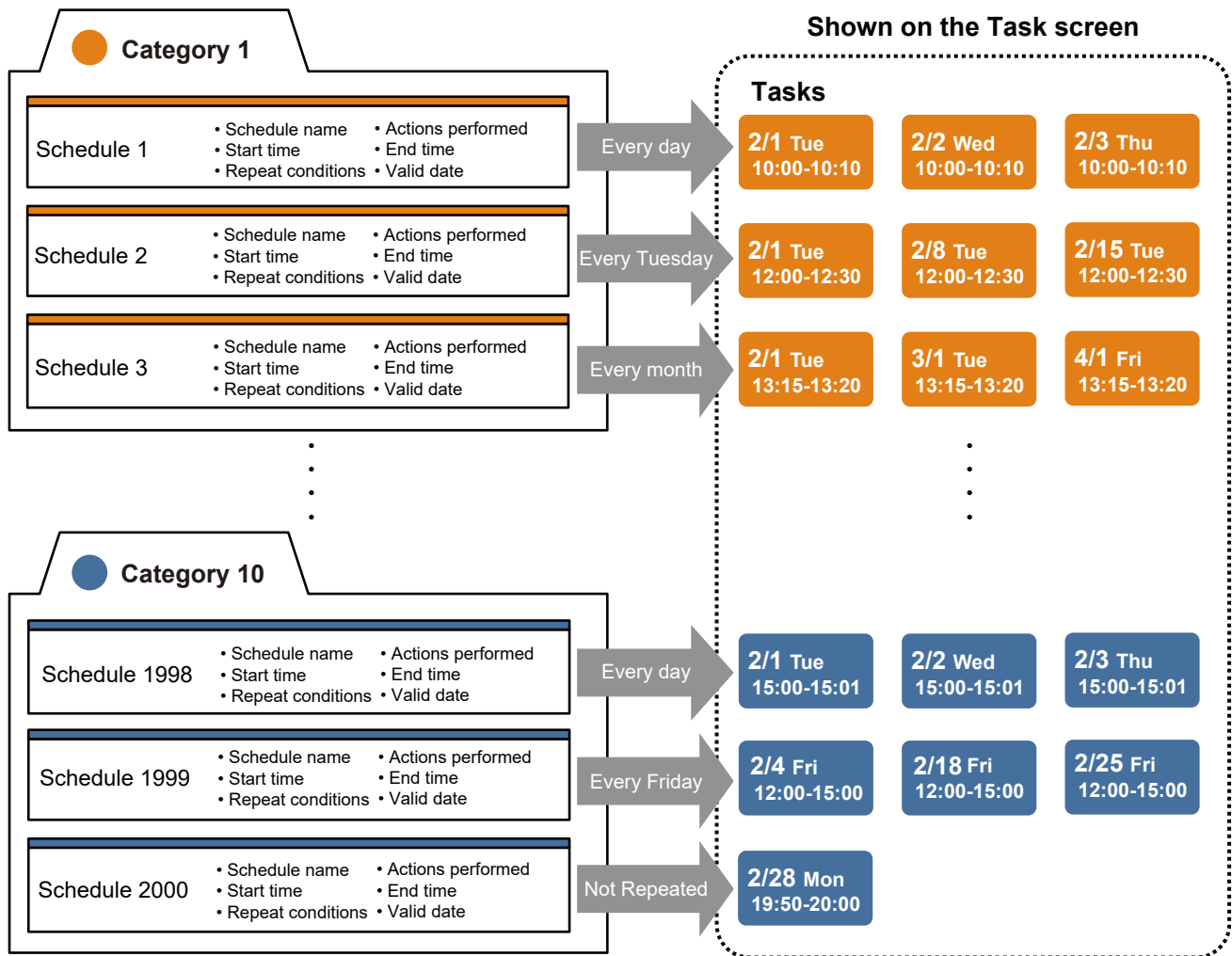

[Description of Terms]

Schedules:

The schedule includes setting information related to actions to be executed, as well as the date and time of the execution or repeat conditions.

Schedules are created based on the actions to be performed, with the schedule name, start/end times and similar parameters set using the Edit Schedule screen. In a schedule, programs for each day/week/month can be enabled on a regular basis, or specific days can be enabled for Repeat settings. Conversely, some of regularly enabled days can also be disabled.

Up to 2,000 schedules can be created. Schedules set to "Endless" in the Repeat settings are continuously retained. However, data for executed schedules (i.e., schedules not set to repeat or those that have passed their last date) is only retained until the end of the month following the last day, and then automatically deleted.

Tasks

Tasks are composed of executable data and contain all pertinent date information that is automatically created by the schedule. Tasks are created for valid dates set in the schedule's Repeat settings, and are displayed on the Task display screen in the colors set for the category. If a task is deleted, the task day is made invalid from the original schedule, and if a task is reedited, a new schedule, separate from the original schedule on which it is based, is created.

If a higher priority task is simultaneously enabled, or a task overlaps others with the same sound source, such unexecuted tasks are shown in gray. Data for completed tasks are kept until the end of the next day, after which they are automatically deleted.

Categories

Categories are used to classify schedules. Each of the Scheduler's 10 categories can be assigned a name and color on the Edit Category screen. Repeat settings for all category-classified schedules can also be batch-edited using the Edit Category Repeat screen. Categories can be utilized by classifying them as follows:

- Collect all of a day's schedules into a single category (e.g., weekday schedule or holiday schedule, etc.)
- Collect all schedules linked by the same Repeat conditions into a single category (e.g., contact output ON/OFF, command start or end, etc.).
- Classify categories by sound source or associated action (e.g., chime, background music, command transmission, etc.).
- Classify categories by broadcast destination (e.g., indoor or outdoor areas, elementary, middle or high school, etc.)

25.2. Scheduler Screen

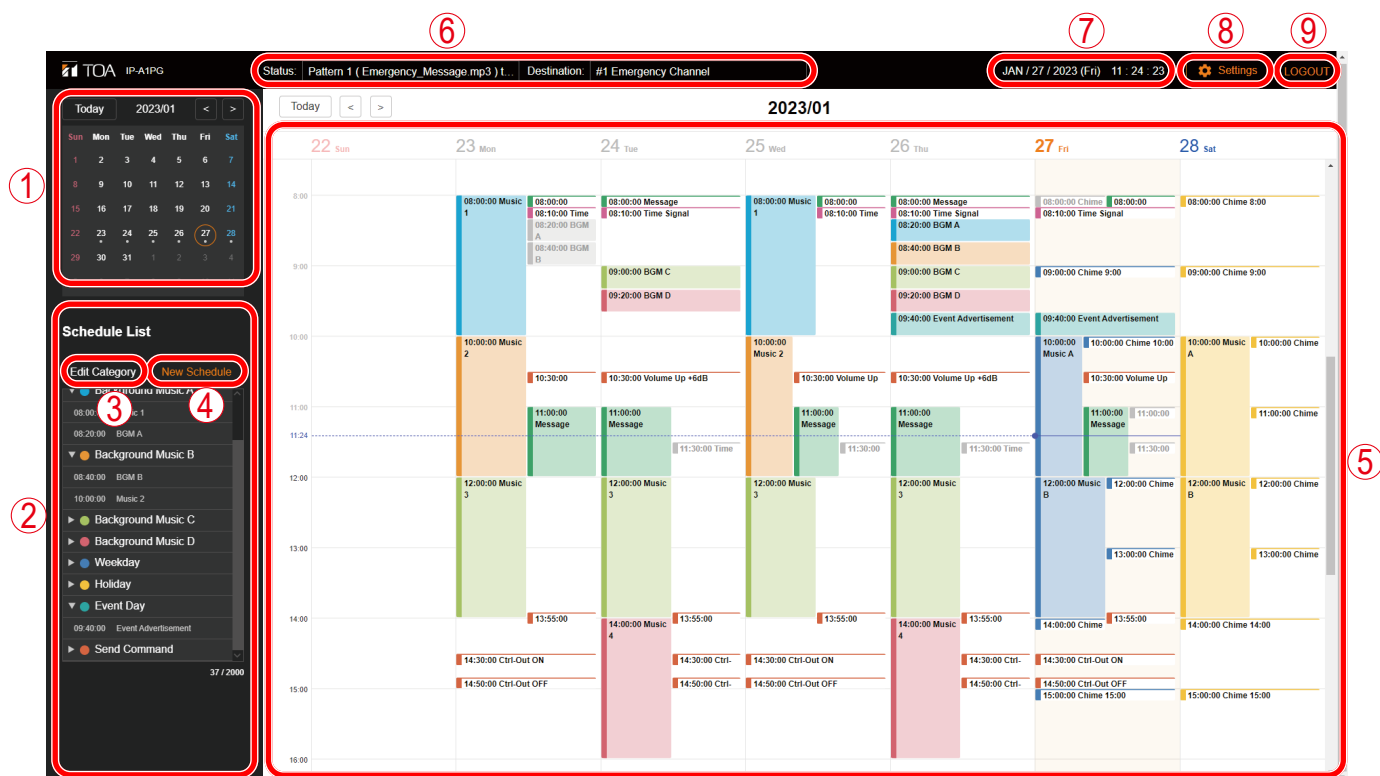

| Item | Contents |
|-----------------------------------|--|
| (1) Calendar | Clicking on a date switches the Task screen to a display of the week that includes the date. A date with a circle (●) at the bottom indicates that the task has been registered, notifying that actions will automatically be executed on that date. The monthly camera display can be switched by clicking on the [Today] [<] [>] buttons. |
| (2) Schedule List | Displays a list of all registered schedules. All schedules are classified by category and registered. When a category is clicked on and opened, all of the schedules assigned to it can be viewed. Schedules are listed from top to bottom in chronological order. The total number of registered schedules is displayed at the bottom of the list. Selected schedules are visible in orange, and disabled (OFF) schedules are shown in gray. No tasks can be initiated by disabled schedules. Clicking on a schedule displays its Schedule Details screen. |
| (3) Edit Category Button | Displays the Edit Category screen, which allows the name and color to be set for each category. Repeat settings can also be batch-edited for all schedules registered in a category. |
| (4) New Schedule Button | Creates a new schedule. Click on this button to display the Edit Schedule screen. |
| (5) Task Screen | Displays all the scheduled tasks to be initiated on each date. All tasks for the week are displayed in the colors of their classified category. The weekly display can be changed by clicking on the [Today] [<] [>] buttons. Clicking on an area where no task is visible will display the Edit Schedule screen, where a new schedule can be created. Clicking on a task displays the Task Details screen, which permits confirmation of the tasks to be executed, editing or deleting of selected tasks, and editing or deleting of entire schedules, including the selected task. Tasks shown in gray indicate inoperative tasks. |
| (6) Status/Destination Display | Displays the device's operating status. During broadcasts, the current sound source is shown in the "Status" area, while all broadcast destinations are displayed in the "Destination" area. |
| (7) Current Date and Time Display | Provides an indication of the device's current date and time. |

| | Item | Contents |
|-----|-----------------|--|
| (8) | Settings Button | Pressing this button switches the current screen to the Settings screen. This screen is used to change sound source patterns or select scheduled broadcast destinations. |
| (9) | LOGOUT Button | Click this button to log out after schedule confirmation or registration is completed. After logging out, the Log In screen is again displayed. |

25.3. Creating a New Schedule

New schedules can be created on the Schedule Settings screen by either clicking on the "New Schedule" button or clicking on a blank area on the Task screen.

Schedule Settings screen

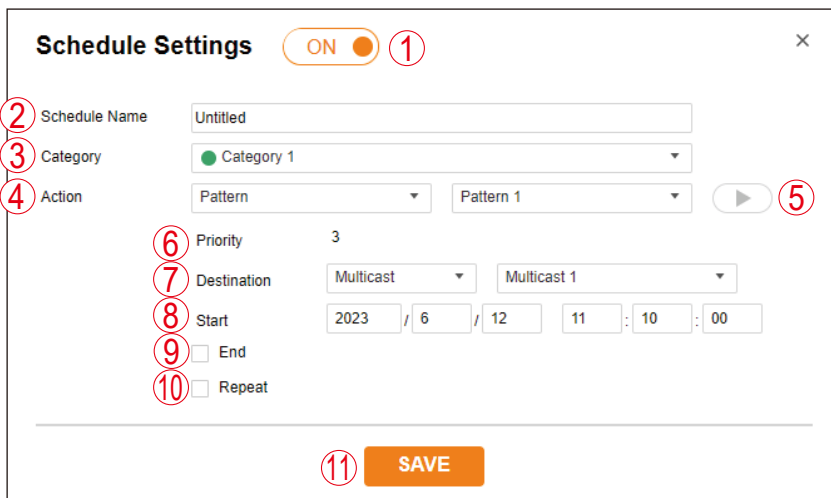

| Item | Contents |
|----------------------------------|---|
| (1) ON/OFF Button | Enables/disables individual schedules. ON: The schedule is enabled. The task will be created when the schedule is saved. OFF: The schedule is disabled. When saved, the schedule will appear grayed out in the Schedule list and no tasks can be created. Default Setting: ON |
| (2) Schedule Name* | Set the schedule name. The same schedule name can also be assigned to multiple schedules. Each schedule is displayed with the preset name appearing in the Schedule List or on the Task screen. Default Setting: Untitled |
| (3) Category | Select the category into which the schedule will be classified. Setting Range: Category 1 – 10 Default Setting: Category 1 |
| (4) Actions | Set the actions to be executed in the schedule. The available setting parameters change for each selected action. Pattern: Executes pattern broadcasting using the internal sound source. The pattern name set on the Pattern Registration screen will be displayed. Setting Range: Pattern: 1 – 20 LINE/MIC IN: Executes broadcasts of the audio received through the LINE/MIC input. PG AUX: Executes broadcasts of the audio received through the AUX input. RM Control Out: Turns the control output ON or OFF. Setting Range: ON / OFF Command: Executes the command set on the Command List screen. The command set name will be displayed. Setting range: Command Set: 0 – 9 Default Setting: Pattern / Pattern 1 |
| (5) Sound Source Playback Button | Appears when Pattern is set as the Action. This is used to play back the sound source assigned to the pattern on a PC, thus allowing its confirmation as an audio output. Tip This is not the button for executing broadcasts. |

* For the type and number of characters that can be used in the settings, please refer to "USABLE CHARACTERS" on p. 90.

| | Item | Contents |
|------|-----------------|--|
| (6) | Priority | <p>If either Pattern or LINE/MIC IN PG or AUX RM is set for the Action, the priority number for the broadcast source set on the Broadcast Priority Setting screen is displayed. The highest priority is Number 1, and the higher the number, the lower the priority. If multiple tasks are registered for the same time frame, the task with the highest priority will be executed according to the priority number.</p> |
| (7) | Destination | <p>Setting either Pattern or LINE/MIC IN PG or AUX RM for the Action further enables the setting of the broadcast destination.</p> <p>For Group broadcasts, select Multicast, then select the multicast transmission channel set on the Destination settings screen.</p> <p>Setting Range: Multicast 1 – 20 Default Setting: Multicast 1</p> <p>RM</p> <p>For Individual broadcasts] Select SIP Target as the broadcast destination, then enter the SIP user ID or IP address of the destination SIP device.</p> <p>[For Group broadcasts using the IP Paging Gateway] Select the SIP Target as the broadcast destination, then enter the SIP user ID or IP address of the IP Paging Gateway that will become the broadcast destination.</p> <p>When the selected broadcast destination is set to DTMF on the IP Paging Gateway's Conversion Settings screen (p. 45), enter the DTMF number that will correspond to the multicast transmission destination.</p> <p>The DTMF number does not need to be entered if the Transfer Destination is set to Fixed.</p> |
| (8) | Start Time | <p>Set the start date and time for execution of the schedule. Schedules that only have the start time set are enabled by the edge trigger^{*2}. If Pattern is selected for the Action, the pattern broadcast is only executed once. If a higher priority broadcast is enabled during this pattern broadcast, the pattern broadcast will not be resumed. If Control Out or Command is selected as the Action, only the start time can be set.</p> |
| (9) | End Time | <p>Set the time for the schedule to end. A start-to-end duration can be set with the range of less than 24 hours. If the end time is set to precede the start time, the broadcast will continue until the registered end time comes around again on the following day. Schedules with set end times are initiated by the level trigger^{*2}.</p> <p>When Pattern is selected as the Action, the pattern broadcast is continuously repeated from the preset start time to the preset end time. If another broadcast with a higher priority is enabled during this period, the pattern broadcast will resume after the higher priority broadcast is finished.^{*3}</p> <p>When LINE/MIC IN PG or AUX RM is selected as the Action, the audio from the LINE/MIC input will be continuously broadcast during the preset start-to-end time period. If another broadcast with a higher priority is made during this period, the LINE/MIC audio broadcast will resume after the higher priority broadcast is finished.</p> |
| (10) | Repeat Settings | <p>Checking this box will display the Edit button, allowing the setting of repeat conditions of the schedule. If the Edit button is clicked, the Repeat Settings screen is displayed (see p. 101). For single operation schedules, be sure this box is unchecked.</p> <p>Default Setting: Unchecked (Repeat setting disabled)</p> |
| (11) | Save Button | <p>Saves the edited contents of the schedule and closes the Edit Schedule screen.</p> |

^{*2} For details regarding Edge- and Level-triggered operations, please refer to the description of the operating sequence in "EVENT SETTINGS SCREEN" on p. 65 and "PRIORITY SETTINGS SCREEN" on p. 71.

*3 If SIP Target is selected as the broadcast destination, the broadcast is not resumed after higher priority broadcasts end.

The setting items for each action are as follows:

| Action | Pattern | LINE/MIC IN PG | AUX RM | Control Out | Command |
|-----------------------|--|-------------------|-----------|-------------|----------------------------------|
| Option for action | Pattern 1 – Pattern 20 | — | — | OFF ON | Command Set 0 – Command Set 9 |
| Priority | ✓ Display of the priority number of the Priority screen | | | — | — |
| Broadcast destination | Multicast 1 – Multicast 20 SIP Target RM | | | — | — |
| Start time | ✓ | | | | |
| End time | ✓ Arbitrary setting | ✓ | ✓ | — | — |
| Repeat setting | ✓ Arbitrary setting | | | | |

25.3.1. About the Repeat Settings Screen

Checking the Repeat box displays the Edit button. Clicking the Edit button displays the Repeat Settings screen, and the type of schedule repetition can be set according to Repeat conditions.

Repeat Settings screen

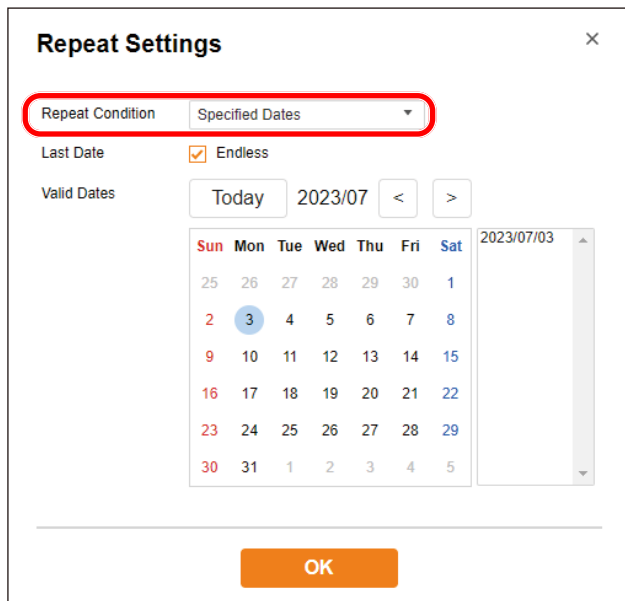

The following 4 options can be used for Repeat conditions. The default setting is "Specified Date."

Note

The valid date setting is reset if repeat conditions are changed and saved.

| Item | Contents |
|----------------|---|
| Specified Date | Select this option when repeating schedules on an irregular basis. Set any valid date from the calendar to execute the schedule. |
| Every Day | Select this option to execute the schedule every day. Every day on the calendar will be displayed as a valid date. Furthermore, clicking on a valid day will disable it, also making it possible to select specific days not to run the schedule. |
| Every Week | Select this option when executing the schedule every week by specifying the day of the week. The day (or days) of the week checked in the Day of the Week setting is displayed as a valid day (the days that the Task is enabled when saved). Furthermore, any day can be set as a valid or invalid day by clicking on a day on the calendar. |
| Every Month | Select this option when executing the schedule on the same date of every month. The date checked in the Date setting will appear as the valid date (the date that the Task is enabled when saved). Furthermore, any date can be set as a valid or invalid date by clicking on a date on the calendar. |

The setting contents for each selected Repeat Condition are as follows:

[When set to "Specified Date"]

Any valid date can be specified for a Repeating schedule.

Repeat Settings screen

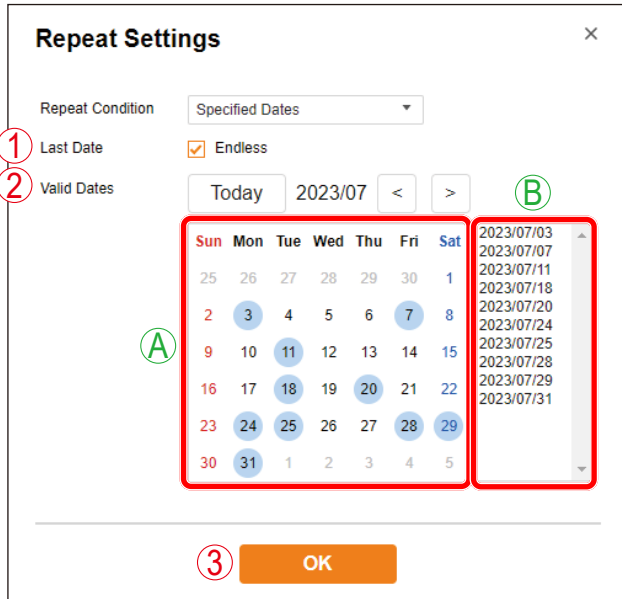

| | Item | Contents |
|-----|------------------|--|
| (1) | Last Repeat Date | <p>If the last date is not to be specified, click the "Endless" checkbox. When "Endless" is enabled, the schedule will continuously initiate tasks without being automatically deleted.</p> <p>The last day of a Repeat schedule can be set by unchecking the Endless checkbox. Data is then retained until the end of the month following the last day, after which it is automatically deleted.</p> <p>Default Setting: Endless (Checked)</p> |
| (2) | Valid Date | <p>(A) Calendar</p> <p>Clicking on a calendar date makes it possible to select a valid date to execute the schedule (the date that the task will be initiated when saved), as well as the date(s) when the schedule will not be executed.</p> <p>Dates set for schedule execution are marked with a circle (●).</p> <p>Dates following a Repeat cycle's Last Date cannot be set as valid dates.</p> <p>The monthly calendar display can be changed by clicking on the [Today] [<] [>] buttons.</p> <p>(B) Valid Date List</p> <p>Clicking on a calendar date displays it with a circle (●), and adds it to the valid date list. The maximum number of selectable valid dates is 400.</p> |
| (3) | OK Button | <p>Click to confirm all changes made in the Repeat settings and return the display to the Edit Schedule screen.</p> |

[When set to "Every Day"]

Schedules can be repeated daily.

Repeat Settings screen

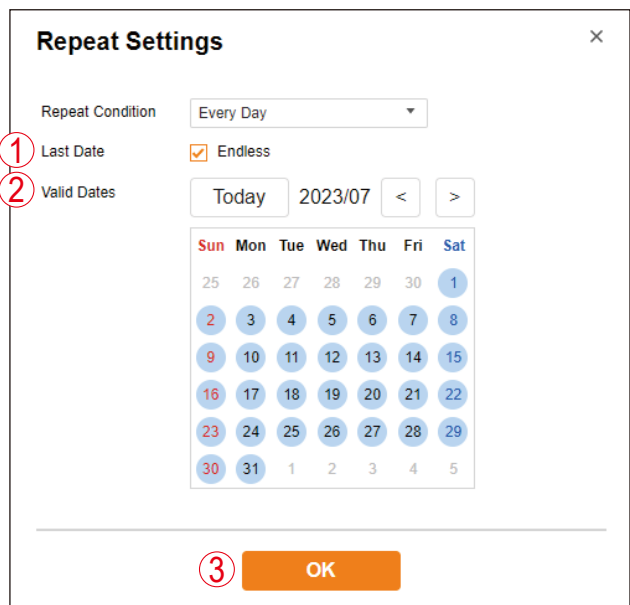

| | Item | Contents |
|-----|------------------|---|
| (1) | Last Repeat Date | <p>If the last date is not to be specified, click the "Endless" checkbox. When "Endless" is enabled, the schedule will continuously initiate tasks without being automatically deleted. The last day of a Repeat schedule can be set by unchecking the Endless checkbox. Data is then retained until the end of the month following the last day, after which it is automatically deleted. Default Setting: Endless (Checked)</p> |
| (2) | Valid Date | <p>Calendar All the dates on the calendar are displayed as valid dates (dates that tasks can be initiated when saved). Selected valid dates for schedule execution are marked with a circle (●). Also, any date can be made Valid or Invalid by simply clicking its date on the calendar. Dates following a Repeat cycle's Last Day cannot be set as valid dates. The monthly calendar display can be changed by clicking on the [Today] [<] [>] buttons.</p> |
| (3) | OK Button | <p>Click to confirm all changes made in the Repeat settings and return the display to the Edit Schedule screen.</p> |

[When set to "Every Week"]

Schedules can be repeated weekly on selected days of the week.

Repeat Settings screen

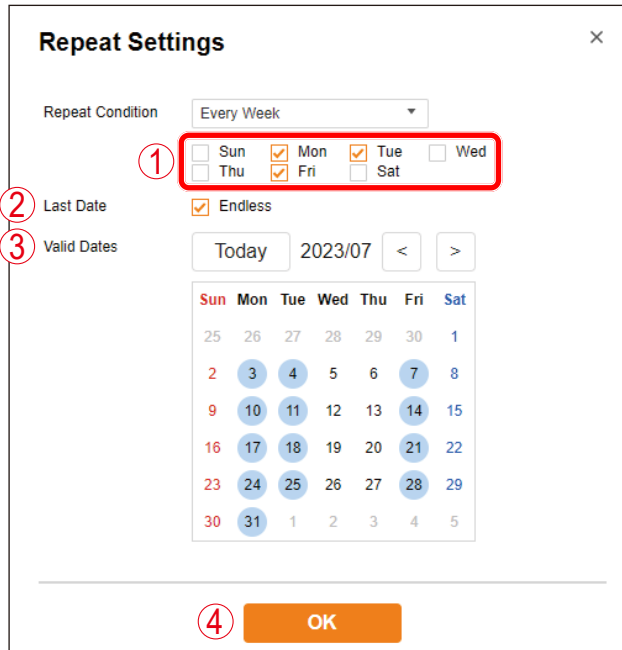

| | Item | Contents |
|-----|--------------------------|---|
| (1) | Day of the Week Settings | Checked days of the week can be set as valid days. |
| (2) | Last Repeat Date | If the last day is not to be specified, click the "Endless" checkbox. When "Endless" is enabled, the schedule will continuously create tasks without being automatically deleted. The last day of a Repeat schedule can be set by unchecking the Endless checkbox. Data is then retained until the end of the month following the last day, after which it is automatically deleted. Default Setting: Endless (Checked) |
| (3) | Valid Date | Calendar The days checked in the Day of the Week settings are displayed as valid dates (dates that tasks can be initiated when saved). Selected valid dates for schedule execution are marked with a circle (●). Also, any day can be made Valid or Invalid by simply clicking its date on the calendar. Dates following a Repeat cycle's Last Date cannot be set as valid dates. The monthly calendar display can be changed by clicking on the [Today] [<] [>] buttons. |
| (4) | OK Button | Click to confirm all changes made in the Repeat settings and return the display to the Edit Schedule screen. |

[When set to "Every Month"]

Schedules can be repeated monthly on selected dates.

Repeat Settings screen

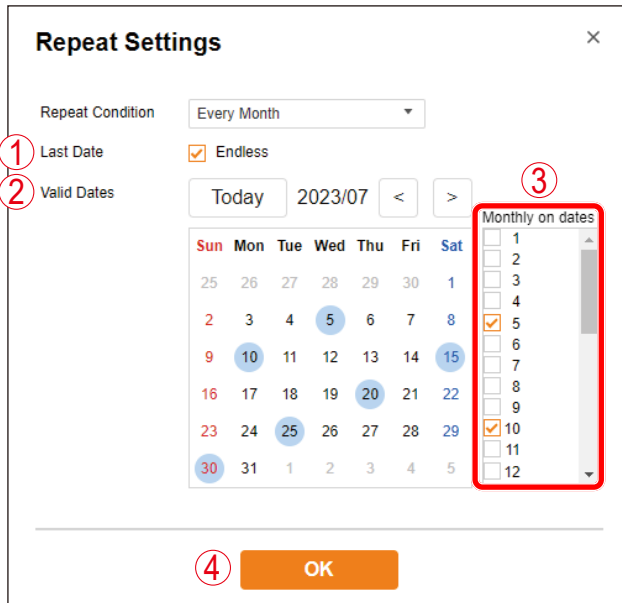

| | Item | Contents |
|-----|------------------|--|
| (1) | Last Repeat Date | If the last date is not to be specified, click the "Endless" checkbox. When "Endless" is enabled, the schedule will continuously create tasks without being automatically deleted. The last day of a Repeat schedule can be set by unchecking the Endless checkbox. Data is then retained until the end of the month following the last day, after which it is automatically deleted. Default Setting: Endless (Checked) |
| (2) | Valid Date | Calendar The dates checked in the Date Settings are displayed as valid dates (dates that tasks can be initiated when saved). Selected valid dates for schedule execution are marked with a circle (●). Also, any date can be made Valid or Invalid by simply clicking its date on the calendar. Dates following a Repeat cycle's Last Date cannot be set as valid dates. The monthly calendar display can be changed by clicking on the [Today] [<] [>] buttons. |
| (3) | Date Settings | Checked dates can be selected as valid dates for monthly Schedule repetition. |
| (4) | OK Button | Click to confirm all changes made in the Repeat settings and return the display to the Edit Schedule screen. |

25.4. Check/Edit/Delete Schedules

Details of all registered schedules can be confirmed on the Schedule list. Display the Schedule Details screen to edit or delete a schedule.

Schedule List

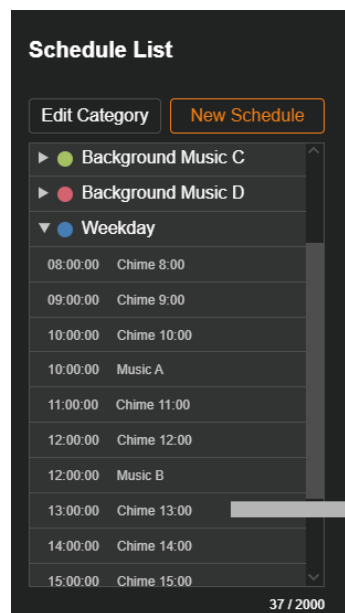

Schedule Details screen

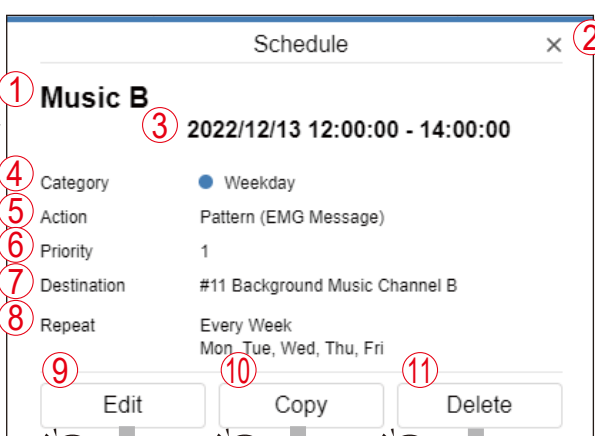

Displays the Delete Confirmation screen.

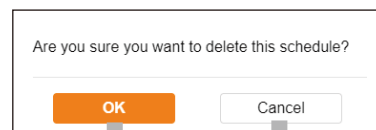

Displays the Edit Schedule screen.

The selected schedule can now be edited.

Displays the Edit Schedule screen.

The displayed schedule is copied and a new schedule is created. The original schedule is not changed.

This schedule is deleted.

| | Item | Contents |
|-----|-------------------|---|
| (1) | Schedule Name | The selected schedule name is displayed. |
| (2) | × Button | Closes the Schedule Details screen. The screen can also be closed by clicking anywhere outside it. |
| (3) | Set Date and Time | Displays the Schedule's start date and its start and end times. Only the start time is displayed for Schedules that only have the start time set. For Schedules that extend over a period of 2 days, the end time is displayed along with the date of the following day. |
| (4) | Category | Displays the name and color of the category into which the schedule is classified. |
| (5) | Actions | Displays the action to be executed in the schedule. Pattern (Pattern Name) LINE/MIC IN PG AUX RM Control Out (ON or OFF) Command (Command Set Name) |
| (6) | Priority | When a pattern, or LINE/MIC IN PG or AUX RM is set for schedule action, the priority number is displayed for the broadcast source, which was set on the Broadcast Priority Setting screen. The highest priority is Number 1, and the higher the number, the lower the priority. If multiple tasks are registered for the same time frame, the task with the highest priority will be executed according to the priority number. |

| | Item | Contents |
|------|------------------------|---|
| (7) | Broadcast Destination | Displays the broadcast destination when either Pattern, or LINE/MIC IN PG or AUX RM is set for schedule action. The group name of the multicast transmission channel set on the Broadcast Destination Settings screen will be displayed. |
| (8) | Repeat Setting | <p>Displays the status of the schedule's Repeat setting.</p> <p>Disable: Repeat setting is invalid.</p> <p>Specified Date: Refers to a state during which Repeat schedule dates have been arbitrarily set. The last valid date is displayed.</p> <p>Every Day: Schedules are set to be repeated daily. The last valid date is displayed.</p> <p>Every Week: Schedules are set to be repeated weekly. The valid days of the week are displayed.</p> <p>Every Month: Schedules are set to be repeated monthly. The valid dates are displayed.</p> |
| (9) | Edit Schedule Button | Clicking on this button displays the Edit Schedule screen, allowing the schedule's settings to be edited. |
| (10) | Copy Schedule Button | Clicking on this button copies the currently displayed schedule and creates a new schedule. The copied source schedule remains unchanged. |
| (11) | Delete Schedule Button | Clicking this button displays the Delete Confirmation screen, with which the selected schedule can be deleted. |

25.5. Task Display and Operation

By editing and saving schedules, tasks can be created and placed on the Task screen. Shown below are descriptions of the task display status and Action operations that can be executed:

25.5.1. Display of an Edge-Triggered Task

The term edge-triggered task refers to tasks with only start times set.

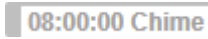
| | Valid Tasks | Invalid Tasks |
|----------------|---|--|
| | Tasks to be executed at start time. Displayed in classified category colors.  | Tasks not executed. Displayed in gray.  |
| Pattern | Broadcasts based on preset patterns are initiated at start time. Pattern broadcasts are only executed once, in accordance with the presets (sound source, number of times, interval, delay time, etc.), which are selected on the Pattern Settings screen. If the current pattern broadcast is interrupted by a higher priority broadcast (initiated by manual operation or remote API), the lower priority pattern broadcast will stop, and not resume when the higher priority broadcast ends. | Conditions that may cause tasks to be grayed out are: <ol style="list-style-type: none"> Cases where the task is not executed due to conflicting broadcast priorities A higher priority broadcast may supersede a lower-priority task, which is then grayed out. Cases where multiple tasks of the same priority are simultaneously initiated When two or more tasks simultaneously execute the same pattern (same sound source/priority), both tasks are displayed in gray. |
| Control Output | The control output is turned ON (or OFF) at start time. | When two or more tasks simultaneously execute the same control output, both tasks are displayed in gray. |
| Command | Preset commands are transmitted at start time. | When two or more tasks simultaneously execute the same command, both tasks are displayed in gray. Even if multiple tasks execute different command sets, they are grayed out if they are simultaneously enabled. |

25.5.2. Level-Triggered Task Display

The term level-triggered task refers to tasks that continuously broadcast during the entire start-to-end time period.

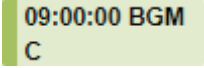
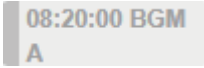
| | Valid Tasks | Invalid Tasks |
|----------------|---|---|
| | <p>Tasks that are executed during the start-to-end time period. Displayed in classified category colors.</p>  | <p>Tasks not executed. Displayed in gray.</p>  |
| Pattern | <p>Broadcasts based on preset patterns are continuously transmitted during the entire start-to-end time period. During this period, pattern broadcasts are played back repeatedly in accordance with the pattern's presets (sound source, interval, delay time, etc.), which are selected on the Pattern Settings screen. If the current pattern broadcast is interrupted by a higher priority broadcast (initiated by manual operation or remote API), the pattern broadcast stops, then resumes when the higher priority broadcast ends (during the pattern's preset period).</p> | <p>Conditions that may cause tasks to be grayed out include:</p> <p>(1) Cases where the task is not executed due to broadcast priority When another task with a higher priority is initiated during the entire start-to-end time period and no time is left for broadcasting*, the task with the lower priority is displayed in gray.</p> <p>(2) Cases where a task of the same priority is executed first When a task with the same priority (same sound source) is executed first, priority is given to the first-initiated task while the later-initiated task is displayed in gray.</p> |
| LINE/MIC Input | <p>Analog audio connected to the LINE/MIC input can be continuously broadcast during the start-to-end time period. If the broadcast is interrupted by a higher priority broadcast (initiated by manual operation or remote API), the broadcast from the LINE/MIC input stops, then resumes when the higher priority broadcast ends (during the preset period).</p> | <p>(3) Cases where tasks of the same priority are simultaneously initiated When broadcasting tasks of the same priority (same sound source) are simultaneously initiated, both tasks are displayed in gray.</p> <p>* If even a minimal amount of time is left available for broadcasting, the task is not grayed out.</p> |

25.6. Confirm/Edit/Delete Tasks

Clicking on a task on the Task screen displays the Task Details screen, which allows the details of the task to be confirmed.

Tasks and schedules can also be deleted or edited whenever the Task Details screen is displayed.

Task screen

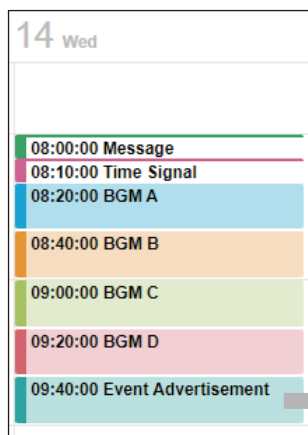

Task Details screen

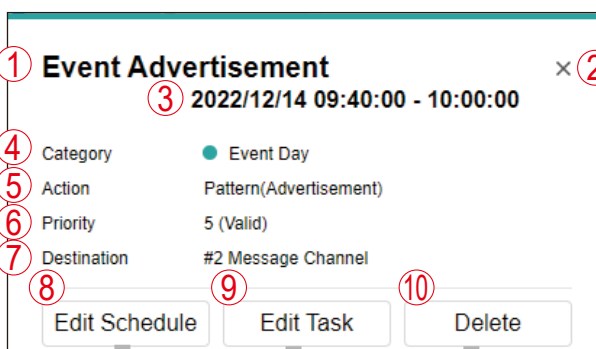

Displays the Edit Schedule screen.

Allows editing of schedule contents, including the selected task. For details, please refer to "[Editing Schedules on the Task Details Screen](#)" on p. 112.

Displays the Edit Task screen.

When a task is edited, a new schedule without the Repeat setting is automatically created that executes the task one time only. The original task is then deleted from the schedule. For details, please refer to "[Editing Tasks on the Task Details Screen](#)" on p. 112.

Displays the Delete Confirmation screen.

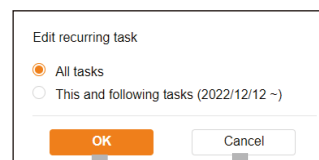

- This Task
Deletes only the selected Task.
- All Tasks
Deletes the entire schedule, including the selected Task.

| | Item | Contents |
|-----|-------------------|--|
| (1) | Schedule Name | The selected task name, which is the same as the schedule name, is displayed. |
| (2) | × Button | Closes the Task Details screen. The screen can also be closed by clicking anywhere outside it. |
| (3) | Set Date and Time | Displays the task's start date and its start and end times. Only the start time is displayed for tasks that only have the start time set. For tasks that extend over a period of 2 days, the end time is displayed along with the date of the following day. |
| (4) | Category | Displays the name and color of the category into which the schedule is classified. |
| (5) | Actions | Displays the action to be executed in the task. Pattern (Pattern Name) LINE/MIC IN PG AUX RM Control Out (ON or OFF) Command (Command Set Name) |

| | Item | Contents |
|------|-----------------------|---|
| (6) | Priority | <p>When a pattern, or the LINE/MIC IN PG or AUX RM is set for task action, the priority number of the broadcast sound source (selected on the Broadcast Priority Settings screen) is displayed. The highest priority is Number 1, and the higher the number, the lower the priority. If multiple tasks simultaneously conflict with each other, only the broadcast with the highest priority is allowed to transmit, as determined by its priority number. The task's current status and other information can be seen next to the priority number.</p> <p>Valid: The highest priority task (among conflicting tasks) that is permitted to broadcast for its entire duration.</p> <p>Partially Valid: Tasks that are interrupted by other broadcasts but are resumed for the remaining period of time.</p> <p>Invalid: Lower priority tasks (among the conflicting tasks) that are not permitted to broadcast in its entire duration (and are displayed in gray).</p> |
| (7) | Broadcast Destination | <p>Displays the broadcast destination when either Pattern, or LINE/MIC IN PG or AUX RM is set for schedule action. The Group Name of the multicast transmission channel PG or SIP Target RM set on the Broadcast Destination Settings screen will be displayed.</p> |
| (8) | Edit Schedule Button | <p>Clicking on this button displays the Edit Schedule screen, which allows the entire schedule to be edited, including the selected task.</p> |
| (9) | Edit Task Button | <p>Clicking on this button displays the Edit Task screen, allowing only the one selected task to be edited. When a task is edited, a new schedule without the Repeat setting is automatically created that executes the task one time only. The original task is then deleted from the schedule.</p> |
| (10) | Delete Button | <p>Clicking on this button displays the Delete Confirmation screen, with which the task or schedule can be deleted. Select whether to delete only the selected task or the entire schedule (all tasks) including the selected task, then delete.</p> |

25.6.1. Editing Schedules on the Task Details Screen

Click on the Edit Schedule button located on the Task Details screen to edit all schedules that contain this task. The following can be selected for editing:

- (1) Edit the schedule for an entire operating period.
- (2) Edit subsequent schedules with the selected task as the start date.

Schedule Settings screen



- All Tasks
Saves the edited contents for the entire period of the schedule and reflects the changes on all tasks.
- This and Following Tasks
Creates a new schedule with the date of this task as the start day. The last repeat day of the original schedule is changed to the day before the selected task.

Note

For the contents of the Edit Schedule screen, please refer to "Creating a New Schedule" on p. 98.

25.6.2. Editing Tasks on the Task Details Screen

The selected task can be edited by clicking the Edit Task button on the Task Details screen. This only edits the task for the selected day. A new schedule is created, which is only executed on one day with no repeat settings.

Task Settings screen



Creates a new schedule that is only executed on one day with no repeat settings. At the same time, the original edited date of the task is deleted from the schedule.

25.7. Editing the Category

Clicking the Edit Category button displays the Edit Category screen, allowing the following edits:

- (1) Change of the category display color.
- (2) Change of category name
- (3) Batch change of repeated settings for all schedules classified into each category.

Tip

Batch editing of Repeat settings is only applicable to schedules that have been set to ON (enabled), with the "Repeat" setting enabled (checked).

Category Settings screen

Repeat Settings for Multiple Schedules screen

| | Item | Contents |
|-----|-----------------------------------|---|
| (1) | Category Color | Select the display color of all the schedules and tasks that belong to a category. The color can be selected from among 10 different colors, and the same color can also be set for different categories. |
| (2) | Category Name* | Set the displayed name of the category. The same name can also be assigned to multiple categories. The category is displayed in the schedule list or for any task with the set name. Default Setting: Category 1 – Category 10 |
| (3) | Repeat Settings Batch Edit Button | Pressing this button opens the Repeat Settings screen, making it possible to batch-edit the repeat settings of all the schedules in a category. Note Only those schedules set to ON (enabled) that have the Repeat Settings box checked can be batch-edited. |

* For the types of characters and number of characters that can be set, please refer to "USABLE CHARACTERS" on p. 90.

| | Item | Contents |
|-----|---|---|
| (4) | Repeat Conditions (Repeat Condition) | <p>Batch-edit the Repeat conditions of all schedules that belong to a category. To maintain each schedule's Repeat conditions without change, select "No Change."</p> <p>Note If the Repeat conditions are changed and saved, the Valid Date settings for all schedules in the same category will be reset. For schedules in which the Valid Dates aren't to be changed by batch editing, please move these schedules to another category in advance.</p> <p>No Change: Maintains the original Repeat conditions for each schedule without changing them. Valid Dates can only be added or deleted by Calendar operation.</p> <p>Specific Date: Allows any day to be designated as a Valid Date for all schedules. Select any day as a Valid Date to execute schedules from the calendar.</p> <p>Every Day: Changes all schedules to daily operation. All the days in the calendar become Valid Dates. Furthermore, any day can be made Valid or Invalid by Calendar operation.</p> <p>Every Week: Changes all schedules so that they are executed on the specific days each week. The days checked in the Day of the Week settings then become Valid Dates. Furthermore, any day can be made Valid or Invalid by Calendar operation.</p> <p>Every Month: Changes all schedules so that they are executed on the same date(s) every month. The dates checked in the Date settings then become Valid Dates. Furthermore, any date can be made Valid or Invalid by Calendar operation.</p> <p>Default Setting: No Change</p> |
| (5) | Valid Date | <p>The calendar is displayed with the following marks to show the status of all schedules that belong to a category:</p> <ul style="list-style-type: none"> ● : Days when tasks are enabled by all of the schedules in the category (complete match) ○ : Days when tasks are enabled by some of the schedules in the category (partial match) <p>Unmarked: Days when no tasks are enabled by any schedule in the category (complete match)</p> <p>By clicking on a date on the calendar, Valid and Invalid Dates can be batch-set for all schedules that belong to a category. The monthly calendar display can be changed by clicking on [Today][<][>].</p> <p>Tip For schedules where the last Repeat day (Last Date) is set, no dates after the last day of repetition can be selected as Valid Dates.</p> |

25.7.1. About Category Editing Using the Repeat Settings for Multiple Schedules

<When arbitrarily selecting Valid Dates to repeat>
 If the Repeat condition is set to "Specified Dates," the following screen is displayed:

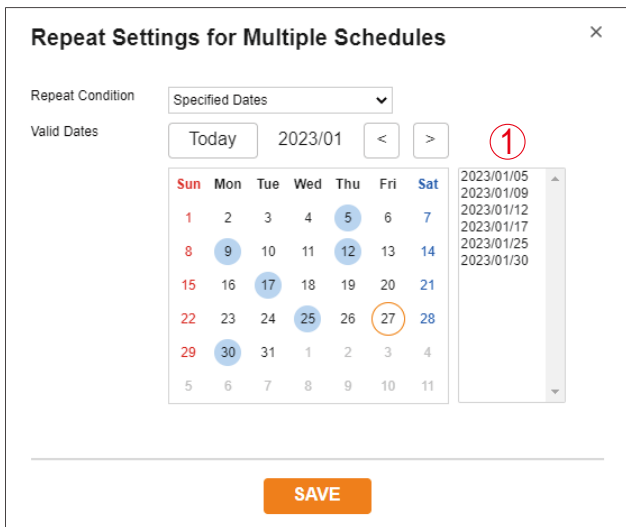

<For Daily Repeats>
 If the Repeat condition is set to "Every Day," the following screen is displayed:

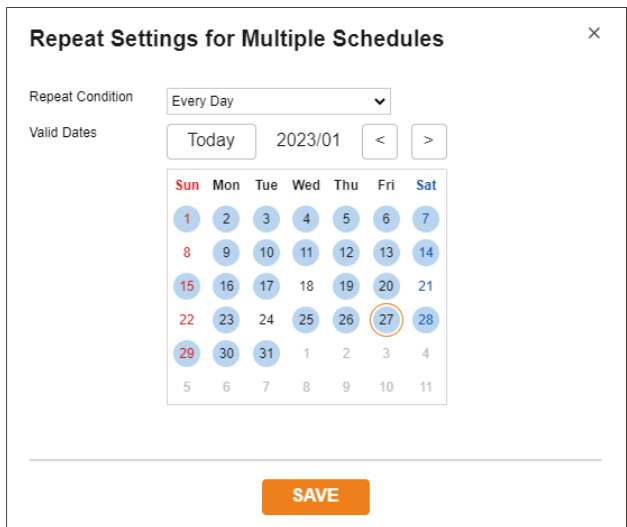

<When specifying the day of the week and repeating every week>
 If the Repeat condition is set to "Every Week," the following screen is displayed:

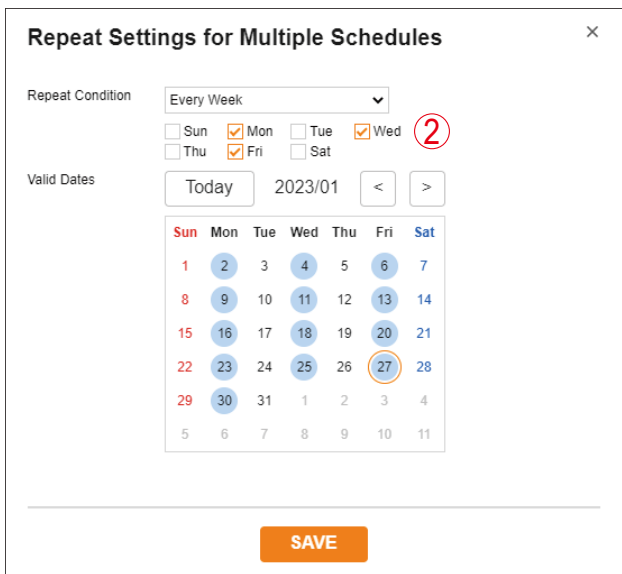

<When specifying the date and repeating every month>
 If the Repeat condition is set to "Every Month," the following screen is displayed:

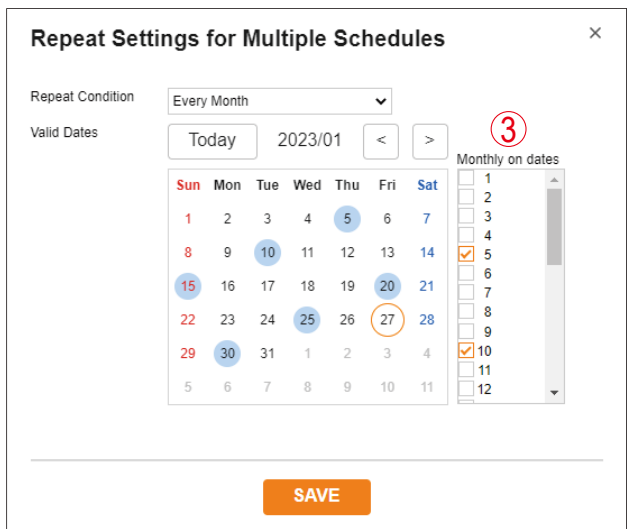

| | Item | Contents |
|-----|--------------------------------------|---|
| (1) | Valid Date List | This list is displayed if "Specified Date" is selected. If a date on the calendar is clicked, the calendar date is shown marked with ●, and it is added to the Valid Date list. The maximum number of Valid Dates that can be specified is 400 days. |
| (2) | Day of the Week Settings (Sun – Sat) | This screen is displayed if the Repeat conditions are set to "Every Week." The checked days of the week can be selected as Valid Dates. |
| (3) | Date Settings (Monthly on Dates) | This screen is displayed if the Repeat conditions are set to "Every Month." The checked dates can be selected as the Valid Dates of every month. |

25.8. Schedule Setting Error Messages

The following error messages may be displayed during Schedule editing. Please refer to What to Do to correct the errors.

| Error Message | Error Contents | What to Do |
|--|---|--|
| The number of schedules exceeds 2000. Please delete old schedules. | Schedule data volume exceeds 2,000 entries. | Delete old schedules in order to reduce total volume to under 2,000 entries. |
| The number of days you have entered on the 'Valid Date' calendar has exceeded 400 days. Please create new schedule. | Except for regular valid dates, a total of up to 400 days can be set for each Schedule, including individually designated valid dates and regular valid dates that have individually been made invalid. The total number of individually set days exceeds 400. | Reselect no more than 400 dates from the Repeat settings calendar. |
| Please set the "Last Date" later than the "Start" date. | The last repeat date has been set to sometime before the start date of the schedule. | Change the last repeat date of the schedule to a valid date. |
| Failed to change schedule data. This schedule data has already been deleted. Please refresh this page. | The schedule data being edited may have been deleted for some reason. | Click OK button and refresh the screen. |

25.9. Schedule Data Reset

The SCHEDULE DATA RESET button located on the Maintenance screen resets only the Schedule data. No other settings are reset or initialized.

For details, please refer to "[MAINTENANCE SCREEN](#)" on p. 77.

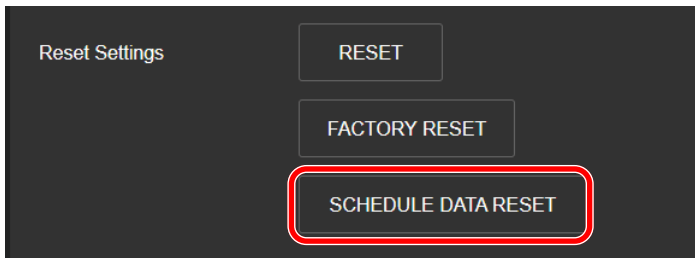

25.10. Uploading the Configuration File (minus Schedule data)

All configuration file data except Schedule data can be uploaded.

For details, please refer to "[Uploading Setting File](#)" on p. 79.

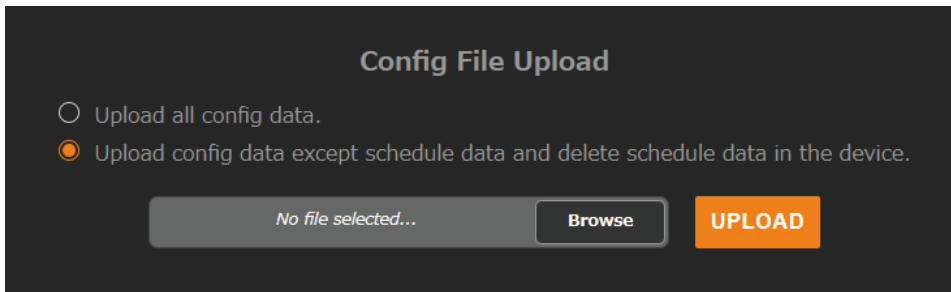

If [Upload config data except schedule data and delete Schedule data in the device.] is selected and the Configuration file is uploaded, all configuration data except the Schedule data is applied to the uploaded Configuration file. If Schedule data has already been registered to the device, the device's Schedule data will be deleted.

26. IP SETTING TOOL

The IP Setting Tool allows multiple devices to be efficiently set up. It also makes it possible to save the setting contents to the PC or upload to the device settings contents stored on the PC. Using this function, the same settings can also be duplicated onto multiple devices. Only use the IP Setting Tool while both the PC and the device are connected to the same network segment. (See "[CONNECTION WITH BROWSER](#)" on p. 27.)

26.1. Before Using:

On the TOA DATA Library (<https://www.toa-products.com/international/>), perform a search for the product number of the device and download the "IPSettingTool.exe" IP Setting Tool. The following shortcut icon appears on the desktop:



26.2. Starting the IP Setting Tool

Double-click on the "IPSettingTool.exe" icon.

Notes

- When the PC has access to multiple network adapters, the confirmation screen as shown at right is displayed. Select the network adapter that can be connected to the device and click on the OK button.

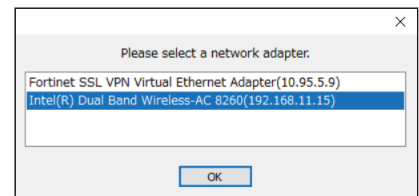

- When the IP Setting Tool is enabled and all connected IP Audio devices are automatically detected and displayed in the list, as shown in the following screen, the right-side buttons appear grayed-out and are rendered inoperative.

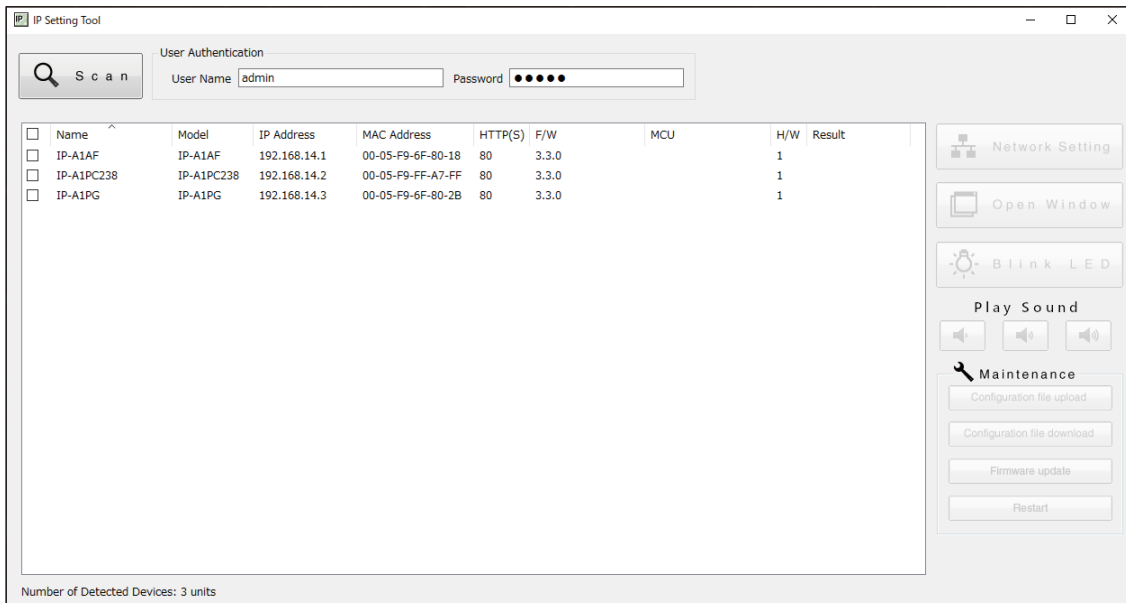

Selecting any device in the list by marking its corresponding checkbox activates its right-side button, thus making it possible to click on.

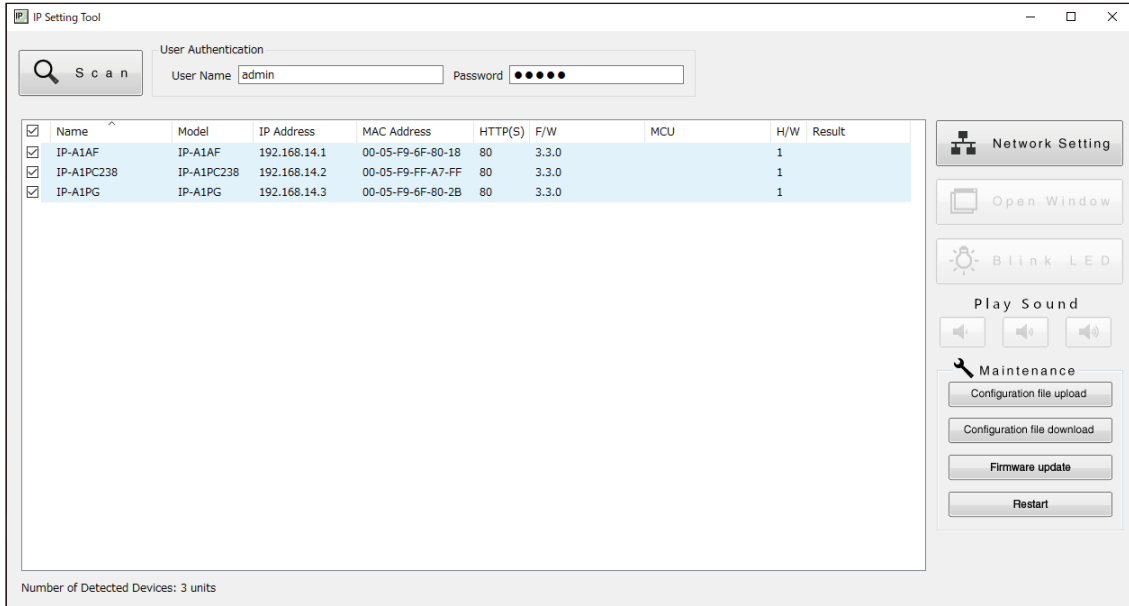

26.3. Setting Method

26.3.1. Display Contents

Notes

- Perform Items (4) and (11) after selecting the device by marking the checkbox in the Detection Results list.
- The operation results for Items (4), (6) to (11) are displayed in the Results field of the Detection Results list.
- Devices currently in Restart mode are not displayed.

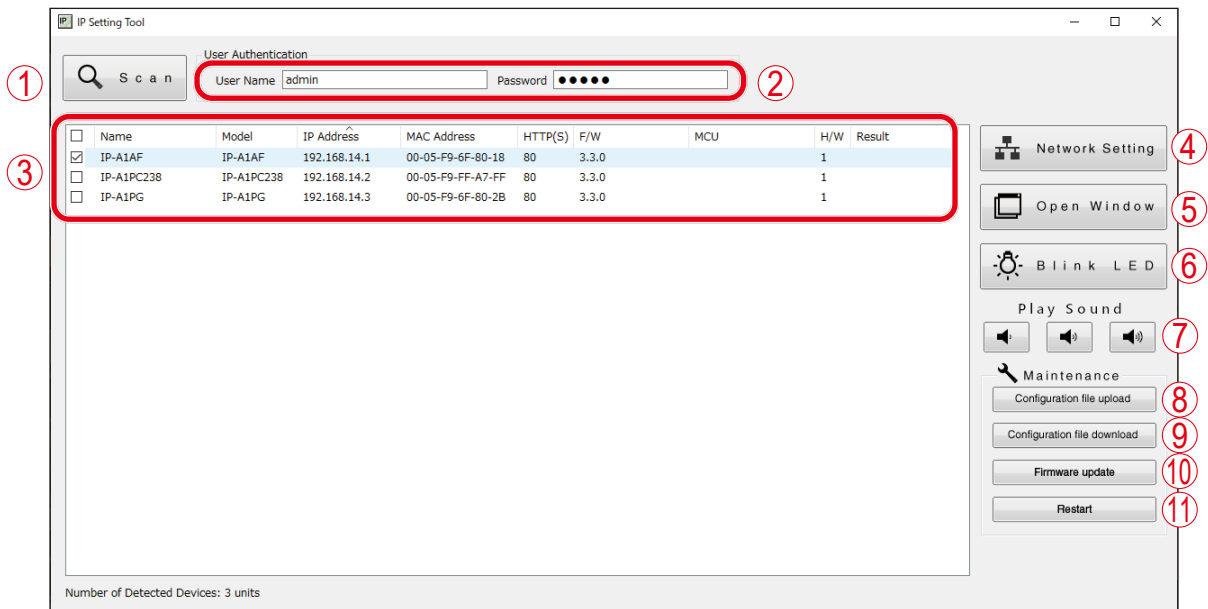

(1) Scan button

Click on this button to detect all IP Audio devices connected to the network. All connected devices are individually detected each time the button is clicked.

(2) Username and Password

Enter the username and password of the device to be operated. When the IP Setting Tool starts up, the device's default values (Username: admin; Password: guest) are entered.

Note

Login to the device cannot be authenticated with the user name or password entered for User privileges.

(3) Detection Results list

Displays a list of detected devices.

(4) Network Setting button

Clicking on this button displays the Network Settings screen. (See "[Network Settings](#)" on p. 121.)

(5) Open Window button

Clicking on this button causes the browser to start up, displaying the Login screen for the selected device. (See "[CONNECTION WITH BROWSER](#)" on p. 27.)

(6) Blink LED button

When clicked, the status indicator for the selected device flashes 3 times.

(7) Play sound buttons (Only enabled when a receiving device is selected)

Clicking one of these buttons broadcasts a test sound from the selected device.

From left, these buttons can be used to broadcast at three different volume levels: low, medium and high.

(8) Configuration file upload button

Click on this button to upload the settings file from the PC. The same settings file can also be simultaneously uploaded to multiple devices. For details, please refer to "[Uploading Settings Files](#)" on p. 124.

(9) Configuration file download button

Click on this button to download the settings file to the PC. The downloaded settings file can be used as the original file when uploading the same settings file to multiple devices. For details, please refer to "[Downloading Settings Files](#)" on p. 125.

(10) Firmware Update button

Click on this button to update the device's firmware. The same firmware update can also be simultaneously carried out on multiple devices. For details, please refer to "[Firmware Update](#)" on p. 126.

(11) Restart button

Click on this button to restart the selected device(s).

26.4. User Authentication

Step 1. Enter the username and password.



Enter the username and password set for the detected device.

When setting up an unconfigured or initialized device, enter the following username and password:

Username: admin

Password: guest

Tip

To change the setting contents of the device(s) detected by the IP Setting Tool, the user authentication requirements of each device must be met.

Step 2. Click on the Scan button.

All detected devices are displayed on the Detection Results list, enabling the operation of buttons (4) to (10).

26.5. Network Settings

Perform all network settings, including the IP address, etc.

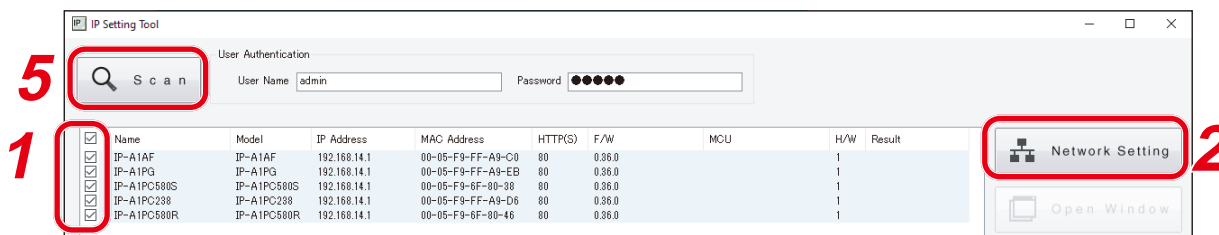

Step 1. Select the device(s) for which network settings will be performed by marking the corresponding checkbox in the Detection Results list.

Step 2. Click on the Network Setting button.

When only one device is selected, the Network settings screen for Single Setting is displayed.

When multiple devices are selected, the following confirmation dialog box is displayed. Clicking on the OK button displays the Network settings screen for Multiple Setting.

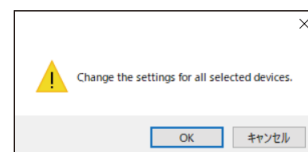

Step 3. Perform network settings.

Set the necessary items on the Single Setting or Multiple Setting screen.

[Network settings screen for Single Setting]

[Network settings screen for Multiple Setting]

| | Item | Contents |
|---|------------------------|---|
| A | Name | <p>Set the terminal name. Initial setting: (Product number)</p> <p>Note Names cannot be set in Multiple Setting. After all other Multiple Setting items have been set, go back and set only the name individually.</p> <p>Tips</p> <ul style="list-style-type: none"> • For usable characters, please refer to "USABLE CHARACTERS" on p. 90. • Max: 31 characters |
| B | IP Address Acquisition | <p>Set the method for acquiring the IP address. Initial setting: Manual</p> <p>Note The device is not compatible with DHCP. Always select Manual, and manually enter the device's network address.</p> |
| C | IP Address | <p>Set the device's IP address. In the case of Multiple Setting, since the IP addresses have consecutive numbers, these are automatically set for all devices. Therefore, enter the smallest numerical value in the left-side field. The IP address of the last consecutive number is displayed in the field at right. Initial setting: 192.168.14.1</p> |
| D | Subnet Mask | <p>Set the subnet mask. Initial setting: 255.255.255.0</p> |
| E | Default Gateway | <p>Set the default gateway. Initial setting: 0.0.0.0</p> |
| F | HTTP port | <p>Set the device's HTTP server port number. Usually, this port is used in its initial setting state. Setting range: 80 and 10000 – 40000 Initial setting: 80</p> |

| | Item | Contents |
|---|-----------------------------|--|
| G | Confirm IP address conflict | <p>Check the checkbox to confirm whether there are any conflicting IP addresses.</p> <p>Tips</p> <ul style="list-style-type: none"> • Even if the checkbox for the item "Confirm IP address conflict" is marked, certain conflicts related to network IP addresses that are different from the network adapter in use cannot be confirmed. • When an IP address conflict is detected, the indication "IP address conflict" appears in the display screen's Results field. |
| H | Set button | Click on this button to finalize the set contents. |

Step 4. Click on the Set button.

This completes the network settings.

The Network settings screen closes and the device automatically restarts.

Step 5. Click on the Scan button.

The display screen is updated.

26.6. Uploading Settings Files

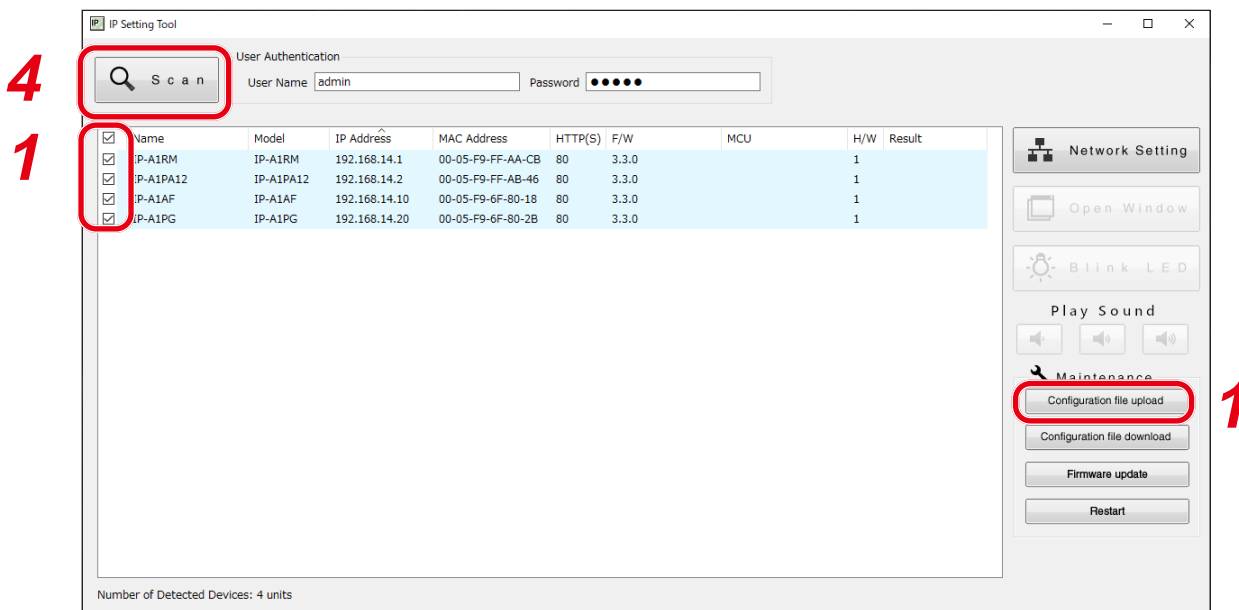

Notes

- Performing uploads during a broadcast will stop current broadcasts.
- The Configuration file (excluding Schedule data) cannot be applied using the IP setting tool.

Step 1. Select the devices and click on the Configuration file upload button.
The file selection screen is displayed.

Step 2. Click on the Select button and select the settings file (extension ".spconf") to be uploaded.

Step 3. Click on the Run button.
Settings file upload begins.
After upload is complete, the indication "OK" is displayed in the Results field, followed by automatic restart.

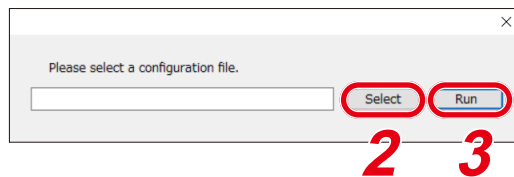

Step 4. Click on the Scan button.
The display screen is updated.

Notes

- Do not restart the device or turn off power during settings file upload.
- If the device is restarted or power is turned off during upload, the settings file could become corrupted, potentially making it impossible to start the device.
- Under circumstances in which the load on the network is high, the indication "No response" may be displayed in the Results field of the Detection Results list. In such cases, simply wait for a while. However, if the Result field is not updated, click on the Scan button again.
- When uploading the settings file, the sound source files are also copied to the device. The user and network settings are not applied to the device even if the settings file is uploaded, and their pre-upload states are maintained.

26.7. Downloading Settings Files

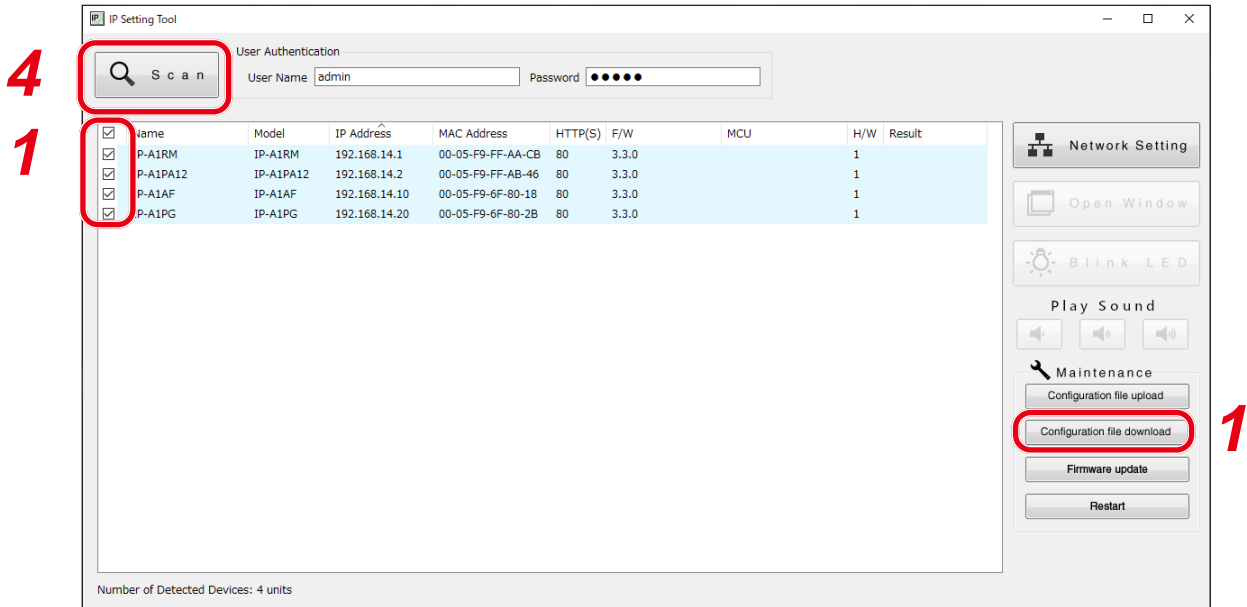

Step 1. Select the devices and click on the Configuration file download button.

The screen for selecting the download destination folder is displayed.

Step 2. Click on the Select button to select the download destination folder.

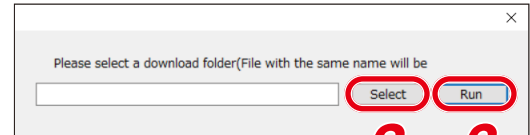

Step 3. Click on the Run button.

Settings file download begins.

After the download is completed, the OK indication appears in the Detection results list's Results field. The extension of the saved settings file is ".spconff."

Notes

- Do not restart the device or turn off power during settings file download. If the device is restarted or power is turned off during download, the settings file could become corrupted, potentially making it impossible to save the file.
- Downloading the settings file causes the setting data, including sound source files, to be downloaded. New network and user settings are not applied when the settings are restored or replicated by means of download and upload.

26.8. Firmware Update

Tip

Download the latest firmware after searching the TOADATA Library (<https://www.toa-products.com/international/>) for the product number.

Note

Do not change the filename of the downloaded firmware.

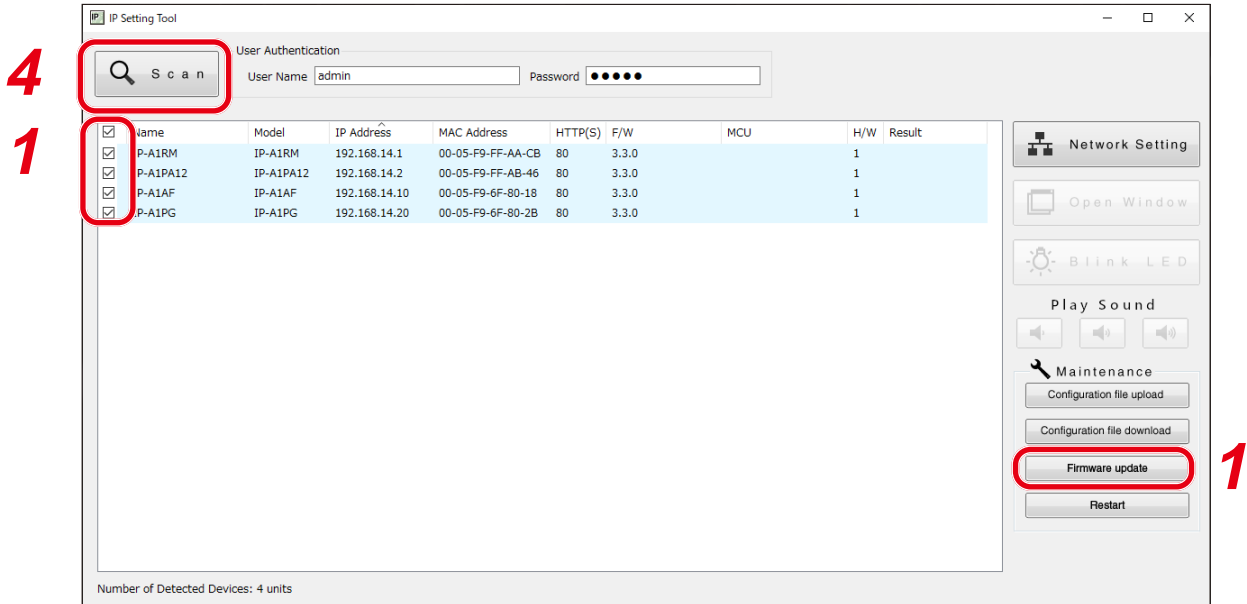

Step 1. Select the devices that will have its firmware updated, and click on the Firmware update button.
The file selection screen is displayed.

Step 2. Click on the Select button to select the firmware file to be updated.

Tip

The firmware-updater's extension is ".bin."



Step 3. Click on the Run button to begin the firmware update.

If the firmware update is complete after restart is finished, the OK indication is displayed in the Results field.

Step 4. Click on the Scan button.
The display screen is updated.

Notes

- Do not restart the device or turn off power during firmware update. If the device is restarted or power is turned off during update, the firmware could become corrupted, potentially making it impossible to start the device.
- Under circumstances in which the load on the network is high, the indication "No response" may be displayed in the Results field of the display screen. In such cases, simply wait for a while. However, if the Result field is not updated, click on the Scan button again.

26.9. Restarting the Device

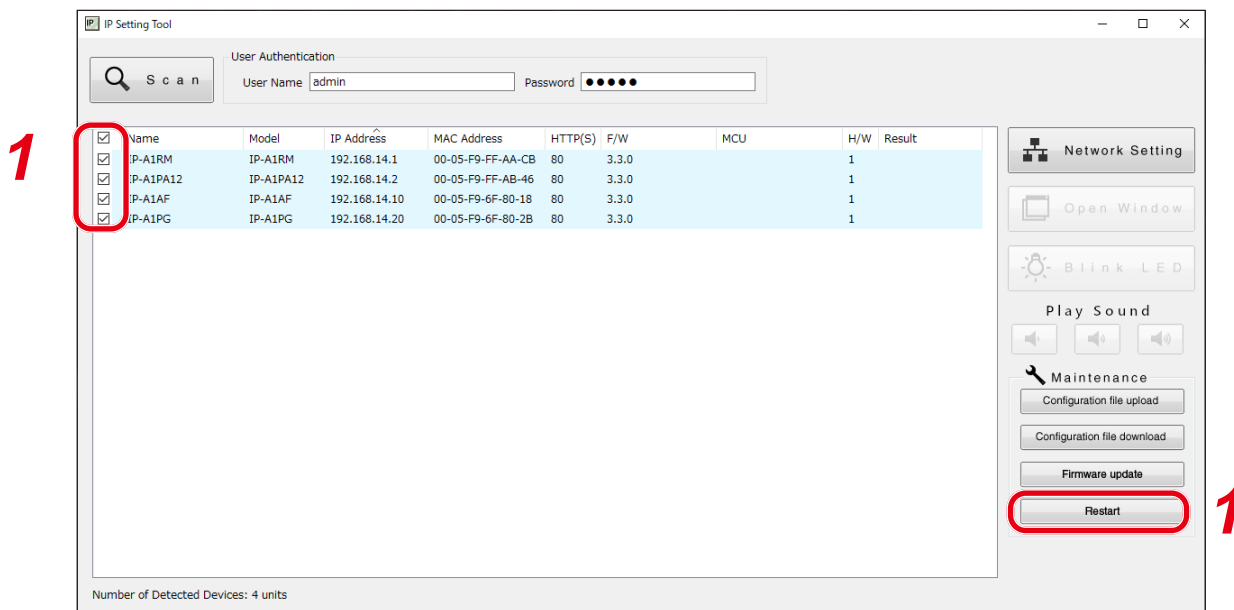

Step 1. Select the devices to be restarted and click on the Restart button.

The confirmation screen is displayed.

Tip

Multiple devices can also be selected for restart.

Step 2. Device restart begins when the OK button is clicked.

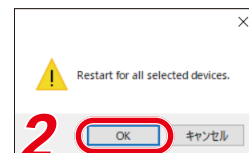

27. SIP STATUS DISPLAY SCREEN

Displays the SIP Status Display screen on the LCD screen of the IP-A1RM whenever a SIP call is disconnected or cannot be started.

Pressing the ► key or Home key returns the display to the home screen.

Details regarding the SIP status display are as follows:

[SIP Status Display screen]

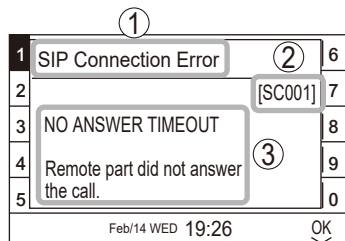

- (1) SIP Status Name
Displays SIP status.
- (2) SIP Status Code
Displays the code number of the current SIP status.
- (3) SIP Status Display
Displays descriptions of SIP status.

| SIP Status Code | SIP Status Display Screen | Contents |
|-----------------|---------------------------|--|
| SC001 | | Displayed whenever the remote part does not respond within the preset call time when a call is made from the device. |
| SC002 | | Displayed whenever an ongoing SIP call from the device is terminated because communications with the remote party have been cut off. |
| SC003 | | Displayed whenever network communications with the remote party cannot be established when a SIP call is made from the device. |
| SC004 | | Displayed whenever the remote party cannot respond when a SIP call is made from the device. |
| SC005 | | Displayed whenever the call is rejected by the remote party when a SIP call is made from the device. |

| SIP Status Code | SIP Status Display Screen | Contents |
|-----------------|---------------------------|--|
| SC006 | | Displayed whenever the audio codec of the device does not match with that of the remote party when a SIP call is made from the device. |
| SC008 | | Displayed whenever the connection is cut off by the SIP server when a SIP call is made from the device. |
| SC009 | | Displayed whenever a SIP call cannot be made because the remote party is currently busy. |
| SC010 | | Displayed whenever an ongoing SIP call from the device is terminated due to a problem with the remote part. |
| SC011 | | Displayed whenever a SIP call cannot be made from the device due to a problem with the remote part. |
| SC012 | | Displayed whenever a SIP call cannot be made from the device because an invalid response has been received from the remote party. |
| SC013 | | Displayed whenever an in-progress SIP call from the device is interrupted by another higher-priority call initiated by the remote party. |

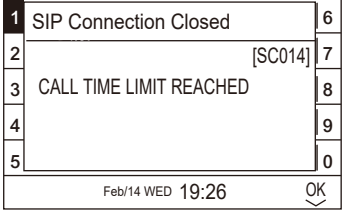
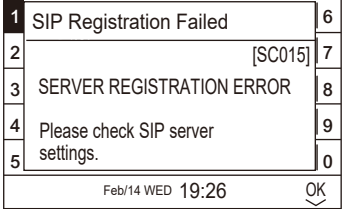
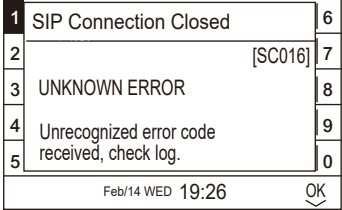
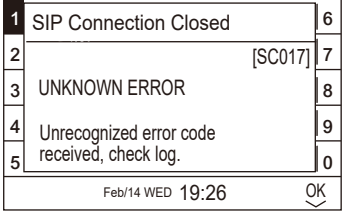
| SIP Status Code | SIP Status Display Screen | Contents |
|-----------------|--|--|
| SC014 |  <p>The screenshot shows a dialog box with a title bar. The main content area contains the following text: '1 SIP Connection Closed' on line 1, '[SC014]' on line 2, '3 CALL TIME LIMIT REACHED' on line 3, and '4 Please check SIP server settings.' on line 4. The bottom of the dialog shows '5 Feb/14 WED 19:26' and an 'OK' button. A vertical column of numbers 6, 7, 8, 9, 0 is on the right side of the dialog.</p> | Displayed whenever an in-progress SIP call is terminated because the conversation has reached its preset time limit. |
| SC015 |  <p>The screenshot shows a dialog box with a title bar. The main content area contains the following text: '1 SIP Registration Failed' on line 1, '[SC015]' on line 2, '3 SERVER REGISTRATION ERROR' on line 3, and '4 Please check SIP server settings.' on line 4. The bottom of the dialog shows '5 Feb/14 WED 19:26' and an 'OK' button. A vertical column of numbers 6, 7, 8, 9, 0 is on the right side of the dialog.</p> | Displayed whenever the device's registration with the SIP server is found to be invalid when a SIP call is made from the device. |
| SC016 |  <p>The screenshot shows a dialog box with a title bar. The main content area contains the following text: '1 SIP Connection Closed' on line 1, '[SC016]' on line 2, '3 UNKNOWN ERROR' on line 3, and '4 Unrecognized error code received, check log.' on line 4. The bottom of the dialog shows '5 Feb/14 WED 19:26' and an 'OK' button. A vertical column of numbers 6, 7, 8, 9, 0 is on the right side of the dialog.</p> | Displayed whenever an unidentified error occurs. |
| SC017 |  <p>The screenshot shows a dialog box with a title bar. The main content area contains the following text: '1 SIP Connection Closed' on line 1, '[SC017]' on line 2, '3 UNKNOWN ERROR' on line 3, and '4 Unrecognized error code received, check log.' on line 4. The bottom of the dialog shows '5 Feb/14 WED 19:26' and an 'OK' button. A vertical column of numbers 6, 7, 8, 9, 0 is on the right side of the dialog.</p> | Displayed whenever an unidentified error occurs. |

28. TROUBLESHOOTING

If a problem concerning the operation of this device is found, we recommend that you follow the procedure below to isolate the problem before requesting repair.

Step 1. Check the Power Supply.

| | | Check |
|-----------------------------------|--|-------|
| Is power being supplied? | Is the Status indicator on the device lit or blinking? If it is off, power is not being supplied. Connect the device to a PoE switching hub to supply power. | |
| | Is the device connected to a PoE switching hub? This device operates on power supplied from a PoE switching hub. Make sure that the device is properly connected to a PoE switching hub that provides adequate power. | |
| | Does the connected equipment exceed the PoE switching hub's maximum power supply capacity? Check the PoE switching hub's instruction manual. If the total electrical load exceeds the capacity of the hub, replace it with a PoE hub that provides ample power supply capacity. | |
| Are there any LAN cable problems? | Is there a faulty contact connection due to a broken tab on the LAN connector? Poor contact between cable and connectors will interfere with both communications and power supply. | |
| | Is a Cat5 or higher grade LAN cable being used? Cables of a lower grade than Cat5 may interfere with power supply and communications. Change to a Cat5 or higher grade cable. | |
| | Are the pin layout and wiring of the RJ-45 LAN connector correct? If the pin layout or wiring is incorrect, communications and power supply may be impaired. Use the correct cable. | |
| | Is the LAN cable over 100 m in length? If cable lengths exceed this limit, communications and power supply may be affected. Correct the wiring to ensure that all lengths are less than 100 m by installing switching hubs wherever long lengths are found. | |

Step 2. Check Network Communications.

| | | Check |
|---|---|-------|
| Are network communications established? | Is the LINK/ACT indicator on the device lit or blinking? If it is not lit or blinking, network communications may not be fully established. | |
| | Can the device's IP address be accessed with a computer's browser to display the webpage Authentication screen? If the webpage Authentication screen cannot be displayed, network communications may not be established. | |
| | Does the device respond to a Ping command sent from the computer to its IP address? If there is no response, network communications may not be established. | |
| Is the webpage displayed correctly? | Is a compatible browser being used? Please access using Microsoft Edge or Google Chrome. | |

| | | Check |
|--|---|-------|
| Can the device be detected by the IP Setting Tool? | Is the latest version of the IP Setting Tool being used? If an older version is being used, the device may not be correctly detected. Please download the latest version of the tool from the TOA DATA Library (https://www.toa-products.com/international/). | |
| | Are the device and the computer installed with the IP Setting Tool connected to the same network segment? If the network segments are different, the device may not be detected. Change the computer's IP address to that of the shared network segment. | |
| | Is the computer's firewall or antivirus software enabled? The influence of a firewall or antivirus software may cause the device to not be detected. Temporarily disable these security functions. | |

Step 3. Check the Operating Status and Settings.

| | | Check |
|---|--|-------|
| Does the Status indicator switch to broadcasting status? | When broadcasting begins, the Status indicator lights up in blue. If there is no change in the Status indicator, even after broadcasting has begun, it may be possible that the system has not switched to broadcast status. If a signal is received by the control input terminal while it is set to Broadcast Disable (on the Event Settings screen), the indicator will not switch to Broadcast status. | |
| Is System Mute enabled? | If the STATUS indicator is flashing red, this indicates that System Mute mode is enabled. An emergency cutoff signal was input to the mute (24 V CUT) terminal or a signal was input to the control input terminal set for System Mute on the Event settings screen. | |
| Does the Status item change on the webpage Status screen? | When shifting to Broadcast status, the Status item changes from the Idle display to the display showing the status of each broadcast in conjunction with the broadcast start operation. If the display does not show the broadcast status, it's possible that the broadcast start operation has not been accepted. | |
| [SIP – Multicast Broadcasting] Is the SIP Registration Status set to "Registered"? | In order to perform SIP broadcasting via the SIP server, the device must be registered on the SIP server. If the device has not been registered, check the following settings on the SIP Settings screen. <ul style="list-style-type: none"> • Is SIP Account Active turned ON? • Is the SIP Server Address/Port setting correct? • Are the User ID, Password, and Authentication ID settings correct? | |
| PG [VMS – Multicast Broadcasting] Can a VMS server/client or network recorder be used to detect/connect to the device? | To perform VMS broadcasting, it is necessary to detect/connect the device with the broadcasting source or its software. If the device cannot be detected/connected to, check the following settings on the VMS Broadcasting Settings screen. <ul style="list-style-type: none"> • Is VMS Connection turned ON? • Are the Control Port settings for both the device and the broadcasting source the same? • Is the RTSP Port set to an appropriate value according to the network environment? (If connected via LAN, there is no need to change the initial settings.) • Are the Username and Password settings correct? | |
| Do the settings of the multicast channel used by the sending and receiving terminals match? | The multicast channel settings for the transmitting device's Destination settings and the receiving device's Multicast settings must match. Check to confirm the following settings: <ul style="list-style-type: none"> • Do the multicast addresses and port numbers for the transmitting and receiving devices match? • Are even numbers being used for the port numbers? • Are the settings for the multicast channel to be used for transmission enabled in the Convert settings? • Is the multicast channel to be used for transmission set as the Destination in the "Event" settings? | |

| | | Check |
|--|---|-------|
| <p>RM</p> <p>Can broadcast conditions be confirmed by way of the IP Remote Microphone's screen display?</p> | <p>During manual broadcasts, the "Status" field displayed on the IP Remote Microphone screen should indicate "Broadcast in Progress." If a broadcast is currently in progress in the background by way of the scheduler or Event Trigger, the contents of the in-progress broadcast are shown in the lower part of the screen.</p> | |
| <p>RM</p> <p>Is the broadcast destination SIP target set correctly?</p> | <p>For SIP broadcasts from the IP Remote Microphone, the SIP user ID or IP address of the broadcast destination device must first be set as the IP address transmission destination.</p> | |
| <p>Do the audio codecs enabled at the transmitting and receiving devices match?</p> | <p>If the audio codec selected at the transmitting device is disabled at the receiving device, data transmissions cannot be decoded and played back via the receiving device.</p> <p>Opus has been added to the audio codec in firmware versions 3.1.0 or later, and made the default setting. Be sure that the firmware of the receiving device is also updated to Ver. 3.1.0 or later, or set the audio codec of the transmitting device to match that of the receiving device.</p> | |

Step 4. Check the Event Trigger.

| | | Check |
|---|---|-------|
| <p>Is a control signal being input?</p> | <p>Is the control signal being input to the control input terminal? Input a no-voltage signal. Since the device can be either Normally Open or Normally Closed, both make and break contacts are supported. Also, because the device is compatible with both Edge and Level detections, these can be set on the Signal Mode line of the Event Settings screen's Control-In settings.</p> | |
| <p>Is the control signal input long enough (in ms)?</p> | <p>The minimum duration for the control input to initiate a short is 200 ms. Be sure that the signal is input for at least 200 ms.</p> | |
| <p>Are the Event settings correctly set?</p> | <p>Is Action correctly set on the Event Settings screen's Control-In settings? When a control signal is received at the control input terminal, the operation selected in Action will be enabled.</p> <p>Patterns 1 – 20: The internal sound source selected in the Pattern settings is used for broadcasts.</p> <p>LINE/MIC IN PG : The sound source connected to LINE/MIC IN is used for broadcasts.</p> <p>AUX RM : The sound source connected to AUX is used for broadcasts.</p> <p>Command Sets 0 – 9: Commands selected from the Command List are transmitted.</p> <p>Broadcast Disable: Terminates the transmission/output of audio broadcasts from the device.</p> <p>System Mute: Stops the device's transmission/output of broadcast audio while also muting audio from the IP Audio receiving device connected to the network.</p> | |
| <p>Was the device restarted after changing its setting?</p> | <p>When the device's settings are changed, some items require a restart before the changed contents are reflected. (See p. 34.)</p> | |
| <p>Are Schedule settings performed correctly?</p> | <p>To execute an action by Schedule, the task must first appear at the given date and time on the Scheduler screen. If the task is not displayed, there may be a problem with the Schedule settings. Please check that the given date and time are registered as a valid date.</p> | |

| | | Check |
|---|---|-------|
| Is the current time set correctly? | The current time must be set correctly to execute actions using the Schedule. Please check to be sure that the current time display on the Settings or Scheduler screen is correct. If the time zone is not set correctly, the current time may be displayed in UTC (Coordinated Universal Time). | |
| Is the correct remote API command being transmitted? | Check that the URI of the transmitted command is correct. Check for the correct command based on the Remote API Specifications. For more information on Remote API Specifications, please contact your nearest TOA subsidiary. | |
| When using Remote API, has Digest Authentication been performed in advance? | In order to control commands by Remote API, Digest Authentication by way of ID & Password is first required. Since commands will only be accepted after Authentication is complete, first check for completed Authentication. | |

Step 5. Check the Sound.

| | | Check |
|--|---|-------|
| Is the device's gain appropriately set for the equipment connected to the LINE/MIC IN PG or AUX RM terminals? | Set the device's gain with the DIP switch, depending on the type of equipment connected to the LINE/MIC IN terminals. <ul style="list-style-type: none"> Line output equipment: LINE / [PAD] 0 dB / [PHANTOM] OFF Dynamic microphone: MIC / [PAD] 0 dB / [PHANTOM] OFF Condenser microphone: MIC / [PAD] -20 dB / [PHANTOM] ON Also, make sure that the output level of the connected equipment is correctly set. | |
| Is the LINE/MIC input volume control turned fully counter-clockwise? | Audio input volume can be adjusted using the LINE/MIC input volume control. PG Adjust the input sound volume while monitoring the LINE/MIC signal indicator so that it remains constantly lit green and only rarely lights red. | |
| PG [SIP – Multicast Broadcasting] Is the SIP phone (or SIP terminal) set to the correct volume? | If the source SIP phone (or SIP device) sound output seems too quiet or too loud, the speaker output may not be set to the correct volume and sound quality. Audio output from the paging gateway can be checked by way of the monitor output. If the volume or sound quality of the monitor output is not correctly set, adjust the audio being transmitted from the SIP phone (or SIP device). If the monitor's output volume or sound quality is correctly set, the volume setting of the receiving device, such as an IP speaker, may not be correct. | |
| PG [VMS – Multicast Broadcasting] Is the volume of the microphone connected to the VMS server/client or network recorder correct? | If the sound volume transmitted from the source VMS server/client or network recorder is either too quiet or too loud, it may be possible that the volume and/or sound quality are not correctly adjusted. Audio output from the paging gateway can be confirmed by way of the monitor output. If the volume or sound quality of the monitor output is not correctly set, adjust the audio coming from the VMS server/client or network recorder. If the volume or sound quality of the monitor output is correct, then the volume settings for the IP speakers or other receiving devices may not be optimal. | |
| [Multicast Broadcasting] Is the volume of each multicast channel correct? | In Multicast broadcasting, the volume of each multicast channel used can be set for each receiving terminal. By adjusting the Audio Settings screen's Input Volume (Multicast 1 – 20), the appropriate volume can be set for each multicast channel. | |

| | | Check |
|---|--|-------|
| <p>[Internal Sound Source Broadcasting] Can sound source files be uploaded to the Media Settings screen?</p> | <p>There may be some restrictions on the sound sources that can be uploaded to the Media Settings screen. Please check to see if any of these restrictions are applicable and try uploading again.</p> <ul style="list-style-type: none"> • Only WAV and MP3 sound source files can be uploaded. • The usable file formats for both WAV and MP3 are fixed. Before use, please check the details (see p. 58). • Sound source files of over 30 MB in size cannot be uploaded. (see p. 58.) • Total Media file size cannot exceed 80 MB. (see p. 58.) • Does the filename contain spaces or characters/symbols that cannot be used? (see p. 92.) | |
| <p>[Internal Sound Source Broadcasting] Is the sound file being played using PLAY button on the Pattern Registration screen set to an appropriate volume?</p> | <p>Depending on the set pattern conditions, by selecting PLAY button on the Pattern Registration screen, the sound source can be played through the monitor output PG or monitor speaker RM in order to confirm the appropriate audio output and volume. If the output volume is not correct, check that the sound source itself is not breaking up and that the pattern-set Input Volume is not too loud.</p> | |

29. WHAT TO DO WHEN IN TROUBLE

| | |
|--------------------------------|---|
| IP address unknown. | <p>If the IP address of the device is unknown, use either of the following procedures to connect:</p> <ol style="list-style-type: none"> 1. Detect the device with the IP setting tool. 2. Initialize the system settings with the reset key, and reconnect using the default IP address. |
| Invalid user name or password. | <p>[If the user information for Administrator privileges is unknown] The default user name and password can be used to log in by first using the reset key to reinitialize.</p> <p>Note Be sure to download the configuration data in advance, as the setting contents will also be erased in the initialization.</p> <p>[If the user information for User privileges is unknown] Log in with Administrator privileges and reset the user name and password on the User Settings screen.</p> |